

# GENERAL LANDSCAPE NOTES

- THE OWNER MAY ELECT TO UPSIZE OR DOWNSIZE PLANT MATERIAL AT THEIR DISCRETION BASED ON SELECTION, AVAILABILITY, OR TO ENHANCE SPECIFIC AREAS OF THE PROJECT. THE CONTRACTOR SHALL VERIFY PLANT MATERIAL SIZES WITH THE OWNER PRIOR TO PURCHASING, SHIPPING OR STOCKING OF PLANT MATERIALS.
- REFER TO IRRIGATION PLANS FOR LIMITS AND TYPES OF IRRIGATION DESIGNED FOR THE LANDSCAPE. IN NO CASE SHALL IRRIGATION BE EMITTED WITHIN THE MINIMUM DISTANCE FROM BUILDING OR WALL FOUNDATIONS AS STIPULATED IN THE GEOTECHNICAL REPORT. ALL IRRIGATION DISTRIBUTION LINES, HEADS AND EMITTERS SHALL BE KEPT OUTSIDE THE MINIMUM DISTANCE AWAY FROM ALL BUILDING AND WALL FOUNDATIONS AS STIPULATED IN THE GEOTECHNICAL REPORT.
- LANDSCAPE MATERIAL LOCATIONS SHALL HAVE PRECEDENCE OVER IRRIGATION MAINLINE AND LATERAL LOCATIONS. COORDINATE INSTALLATION OF IRRIGATION EQUIPMENT SO THAT IT DOES NOT INTERFERE WITH THE PLANTING OF TREES OR OTHER LANDSCAPE MATERIAL.
- THE LANDSCAPE CONTRACTOR SHALL BE RESPONSIBLE FOR ENSURING POSITIVE DRAINAGE EXISTS IN ALL LANDSCAPE AREAS. SURFACE DRAINAGE ON LANDSCAPE AREAS SHALL NOT FLOW TOWARD STRUCTURES AND FOUNDATIONS. MAINTAIN SLOPE AWAY FROM FOUNDATIONS PER THE GEOTECHNICAL REPORT RECOMMENDATIONS. ALL LANDSCAPE AREAS BETWEEN WALKS AND CURBS SHALL DRAIN FREELY TO THE CURB. IN NO CASE SHALL THE GRADE, TURF THATCH, OR OTHER LANDSCAPE MATERIALS DAM WATER AGAINST WALKS. MINIMUM SLOPES ON LANDSCAPE AREAS SHALL BE 2%; MAXIMUM SLOPE SHALL BE 25% UNLESS SPECIFICALLY IDENTIFIED ON THE PLANS OR APPROVED BY THE OWNER.
- PRIOR TO INSTALLATION OF PLANT MATERIALS, AREAS THAT HAVE BEEN COMPACTED OR DISTURBED SHALL BE THOROUGHLY LOOSENEED TO A DEPTH OF AT LEAST 6" AND AMENDED PER SPECIFICATIONS.
- TESTING OF EXISTING SOILS IN LANDSCAPE AREAS SHALL BE CONDUCTED TO IDENTIFY NUTRIENTS/CONTAMINANT LEVELS. REVIEW TESTING FOR RECOMMENDED AMOUNTS OF SOIL AMENDMENT. USE SOIL AMENDMENTS IN MODERATION WITH NATIVE PLANTS. THE FOLLOWING SCHEDULE SPECIFIES GENERAL SOIL AMENDMENT RECOMMENDATIONS PER 1000 SQUARE FEET OF LANDSCAPE AREAS:  
 BLUEGRASS AND HIGH-WATER PLANTINGS: 5 CUBIC YARDS/1000 SF  
 SHRUBS, PERENNIALS, & MODERATE-LOW-WATER PLANTINGS: 3 CUBIC YARDS/1000 SF  
 ENHANCED NATIVE TURF: 1-2 CUBIC YARDS/1000 SF  
 IRRIGATED NAIVE GRASS AREAS: NONE REQUIRED
- TREES SHALL NOT BE LOCATED IN DRAINAGE SWALES, DRAINAGE AREAS, OR UTILITY EASEMENTS.
- ALL TREES ARE TO BE STAKED AND GUYED PER DETAILS FOR A PERIOD OF 1 YEAR.
- ALL TREES IN SEED OR TURF AREAS SHALL RECEIVE MULCH RINGS.
- SHRUB, GROUND COVER AND PERENNIAL BEDS ARE TO BE CONTAINED BY 4" x 14 GAUGE ROLL TOP, INTERLOCKING TYPE EDGER, JDR DURAEDGE OR EQUAL. EDGER IS NOT REQUIRED WHEN ADJACENT TO CURBS, WALLS, WALKS OR SOLID FENCES WITHIN 3" OF PRE-MULCHED FINAL GRADE.
- MULCH SHRUB BEDS WITH MIN. 3" DEPTH, 5/8" MINUS LANDSCAPE ROCK. ALL GROUND COVER AND PERENNIAL FLOWER BEDS SHALL BE MULCHED WITH 3" DEPTH, SQUEEGEE 3/8" MINUS LANDSCAPE ROCK MULCH.  
 USE OF WEED CONTROL FABRIC IS NOT RECOMMENDED TO POTENTIAL MULCH MOVEMENT THAT CAN LEAVE FABRIC EXPOSED. WEED BARRIER ALSO REDUCES THE INFILTRATION OF NATURAL PRECIPITATION.
- AT SEED AREA BOUNDARIES ADJACENT TO EXISTING NATIVE AREAS, OVERLAP ABUTTING NATIVE AREAS BY THE FULL WIDTH OF THE SEEDER.
- SHRUB BED PLANTING DESIGN SHOULD ACHIEVE MINIMUM 50% PLANT COVERAGE WITHIN 2-3 GROWING SEASONS. EXCEPTIONS INCLUDE:  
 AREAS WITHIN 5-FEET OF STRUCTURES LEFT UNPLANTED FOR LOW-FLAMMABILITY DESIGN CONSIDERATIONS  
 AREAS WITHIN 5-FEET OF STRUCTURES WHERE IRRIGATION APPLICATION IS EXCLUDED TO LIMIT WATER NEAR FOUNDATIONS WHERE EXPANSIVE SOILS ARE PRESENT

# LANDSCAPE LEGEND

CODE	DESCRIPTION	APPLICATION	WATER NEEDED (GAL/SF/YR)
WA-01	TURF - BLUEGRASS	HEAVY TRAFFIC AND ACTIVE USE, MAINTAIN AT 1.5"-2.5" HEIGHT	22
WA-02	TURF - BUFFALO/BLUE GRAMA	PASSIVE USE, LOWER MAINTENANCE TURF ALTERNATIVE, 3"-12" HEIGHT	12
WA-03	TURF - DOG TUFF	WARM SEASON TURF ALTERNATIVE (CONTAINS EDGES TO LIMIT SPREADING), 2"-5" HEIGHT	12
WA-04	TURF - TAHOMA 31 BERMUDAGRASS	HEAVY TRAFFIC AREA ALTERNATIVE TO BLUEGRASS WITH LOWER WATER REQUIREMENT, 1"-3" HEIGHT	12
WA-05	NATIVE GRASS - IRRIGATED ENHANCED	LOW GROWING NATIVE MIX (18-24"), SEEDING INSTALLATION, IRRIGATED BUFFER TO NATURALIZED LANDSCAPE	8
WA-06	NATIVE GRASS - IRRIGATED	ALTERNATIVE NATIVE MIX (UP TO 36" HEIGHT), SEEDING INSTALLATION, IRRIGATION FOR ESTABLISHMENT	3
WA-07	PLANTING BED - HIGH WATER	VEGETABLE GARDENING OR OTHER SIMILAR FUNCTIONAL USE	14
WA-08	PLANTING BED - MODERATE USE	PLANTS WATERED TO ESTABLISH AND SUPPLEMENTED DURING GROWING SEASON	12
WA-09	PLANTING BED - LOW WATER	NATIVE PLANTS WATERED TO ESTABLISH AND LARGELY SUSTAINED BY ANNUAL PRECIPITATION	8

CODE	DESCRIPTION
M-01	STEEL EDGING
M-02	SPODE EDGING
M-03	PERFORATED EDGER
M-04	OPTIONAL GARDEN IN-A-BOX AREA

CODE	DESCRIPTION
M-05	LANDSCAPE ROCK
M-06	CRUSHER FINES
M-07	DECORATIVE ROCK

SYMBOL	DESCRIPTION
	M-08 LANDSCAPE BOULDER

CODE	DESCRIPTION
P-01	ASPHALT PAVEMENT
P-02	PAVERS
P-03	DECORATIVE PAVERS
P-04	POROUS PAVERS
P-05	CONCRETE PAVEMENT

CODE	DESCRIPTION
N-01	TREE LOCATIONS
N-02	SHRUB PLANTING
N-03	PERENNIAL PLANT LAYOUT
N-04	SHED
N-05	GRILL
N-06	FURNITURE BY OWNER
N-07	MOW LINE
N-08	RAIN GARDEN
N-09	RAIN BARREL
N-10	SWALE/CULVERT
N-11	CONCRETE/FLAGSTONE STEPPERS
N-12	FREESTANDING WALL
N-13	RETAINING WALL
N-14	LANDSCAPE BOULDER WALL
N-15	PLANTER WALL

### TEMPLATE SUMMARY CHART

TEMPLATE #	SIZE	DESCRIPTION
1	45,730 SF	LARGE LOT
2	7,400 SF	CONTEMPORARY GEOMETRIC
3	3,020 SF	WATER-WISE ADAPTIVE
4	14,090 SF	NATURALISTIC
5	6,750 SF	COLORADO CONTEMPORARY
6	5,770 SF	MODERN ADAPTIVE

# SOD AND SEED MIXES

### BLUEGRASS (SOD)

OVERHEAD SPRAY IRRIGATION

COMMON NAME	% OF TOTAL	WATER USE
TALL FESCUE	90%	HIGH
KENTUCKY BLUEGRASS	10%	HIGH
	100%	

### BUFFALOGRASS & BLUE GRAMA TURF SEED MIX

OVERHEAD SPRAY IRRIGATION

COMMON NAME	% OF TOTAL	WATER USE
BUFFALO GRASS, CODY OR BOWIE	80%	LOW
BLUE GRAMA, ALMA OR BAD RIVER	20%	LOW
	100%	

SEEDING RATE: (DRILL) 2 LBS PLS / 1,000 SF; (BROADCAST) 4 LBS PLS /1,000 SF

### DOG TUFF TURF (PLUGS)

OVERHEAD SPRAY IRRIGATION  
INSTALL AS PLUGS WITH ON-CENTER SPACING AS RECOMMENDED BY NURSERY STOCK SUPPLIER

SCIENTIFIC NAME	% OF TOTAL	WATER USE
CYNADON 'PWIN04S'	100%	LOW

### TAHOMA 31 BERMUDAGRASS (SOD)

OVERHEAD SPRAY IRRIGATION  
INSTALL AS SOD

SCIENTIFIC NAME	% OF TOTAL	WATER USE
CYNODON DACTYLON X C. TRANSVAALENSIS	100%	LOW

### ENHANCED NATIVE TURF (SEED)

OVERHEAD SPRAY IRRIGATION

COMMON NAME	% OF TOTAL	WATER USE
BUFFALO GRASS, CODY OR BOWIE	40%	LOW
BLUE GRAMA, ALMA OR BAD RIVER	20%	LOW
SIDEOATS GRAMA, VAUGHN OR EL RENO	20%	LOW
SLENDER WHEATGRASS	20%	LOW
	100%	

SEEDING RATE: (DRILL) 3 LBS PURE LIVE SEED / 1,000 SF; (BROADCAST) 3 LBS PURE LIVE SEED / 1,000 SF

### IRRIGATED NATIVE GRASS SEED

OVERHEAD SPRAY IRRIGATION  
REFER TO BOULDER COUNTY RECOMMENDED NATIVE SEED MIXES

COMMON NAME	% OF TOTAL	WATER USE
SIDE OATS GRAMA, VAUGHN	10%	LOW
BLUE GRAMA, NATIVE, ALMA, OR HACHITA	15%	LOW
SLENDER WHEATGRASS, SAN LUIS	20%	LOW
JUNEGRASS	10%	LOW
WESTERN WHEATGRASS, ARRIBA	10%	LOW
WESTERN WHEATGRASS	10%	LOW
SWITCHGRASS, BLACKWELL OR NEBRASKA 28	7%	LOW
LITTLE BLUESTEM, CIMMARON OR PASTURA	8%	LOW
GREEN NEEDLEGRASS, LODORM OR NATIVE	10%	LOW
	100%	

SEEDING RATE: (DRILL) 3 LBS PURE LIVE SEED / 1,000 SF; (BROADCAST) 3 LBS PURE LIVE SEED / 1,000 SF

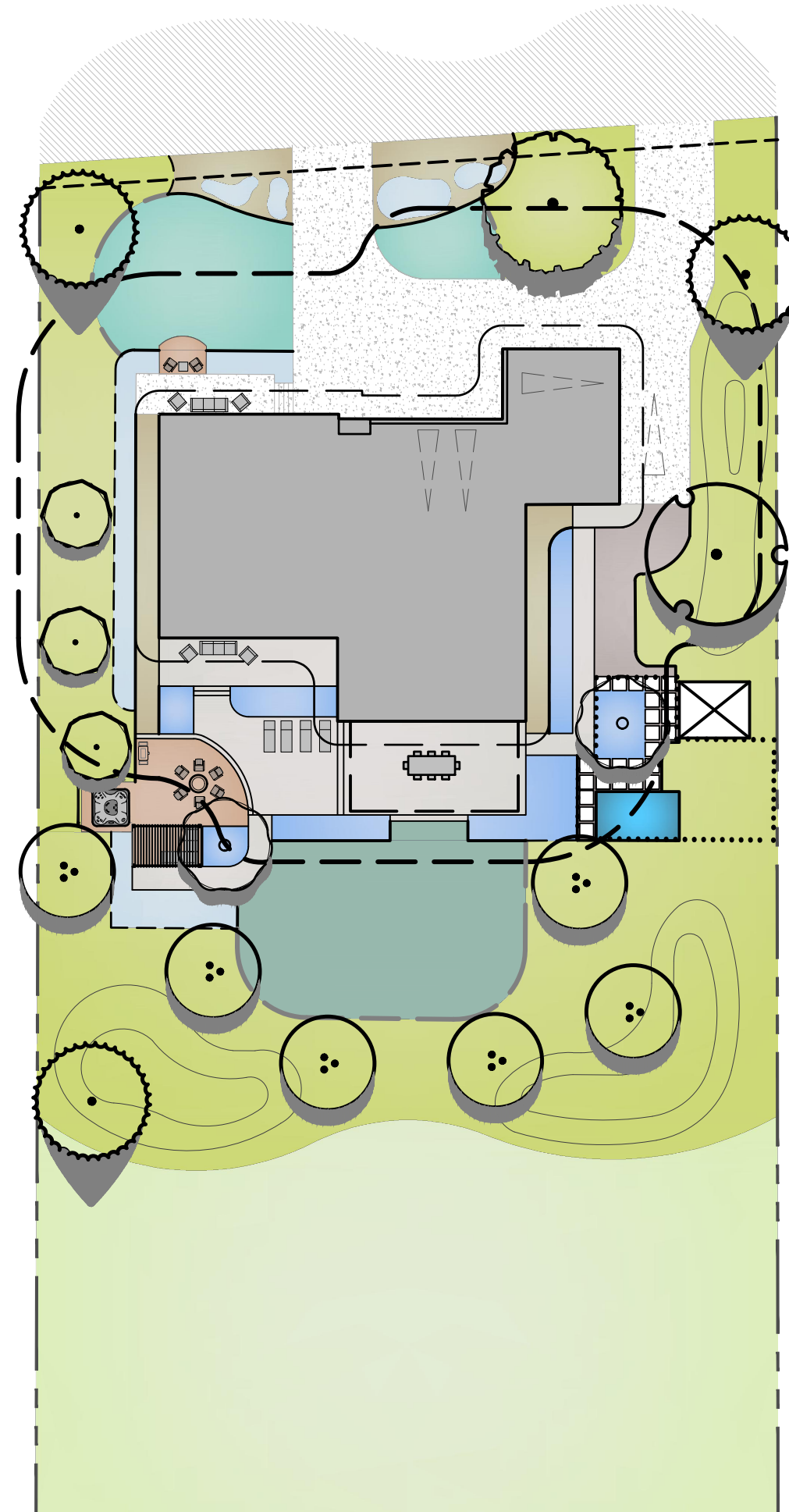

1

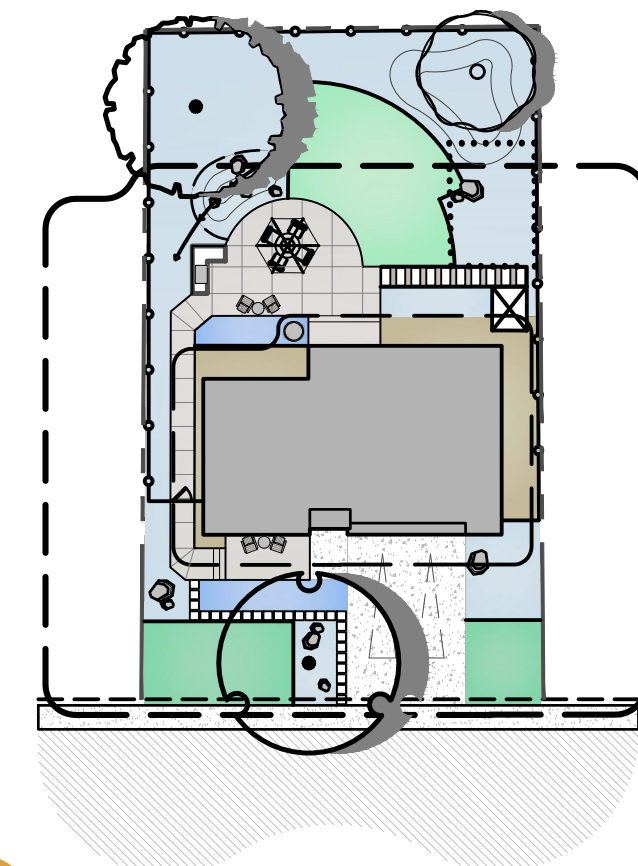

2

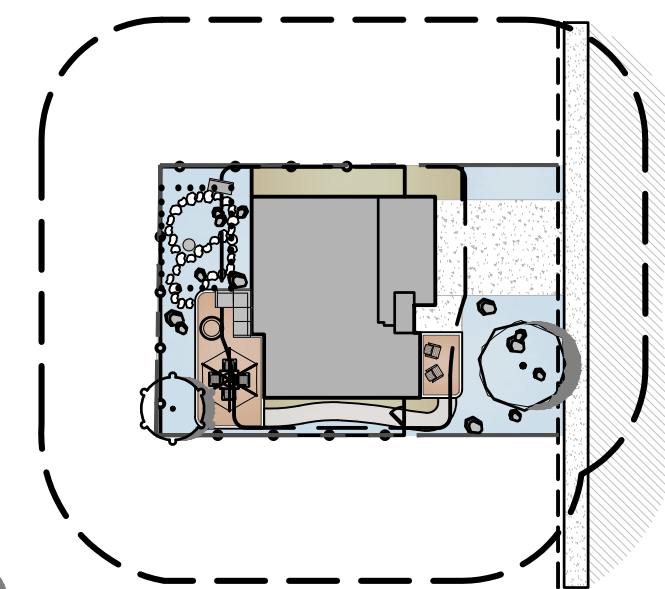

3

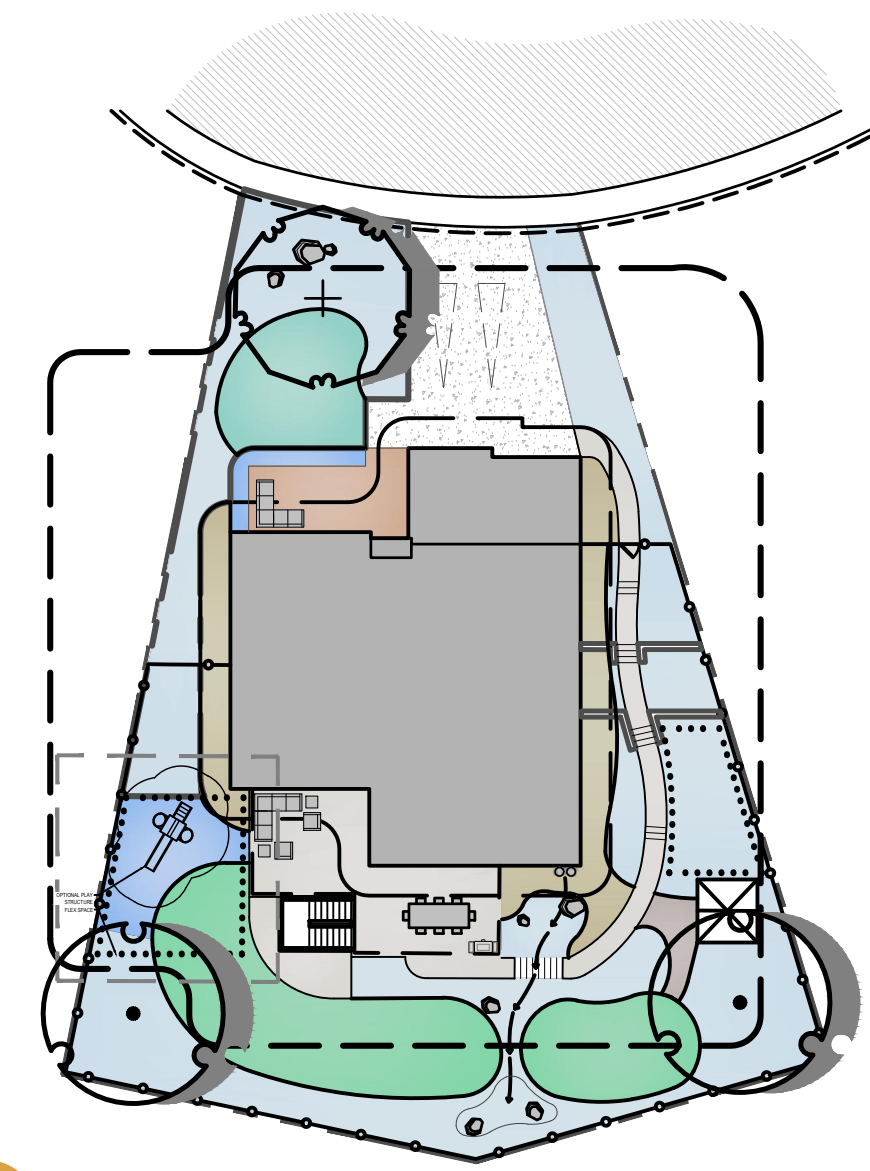

4

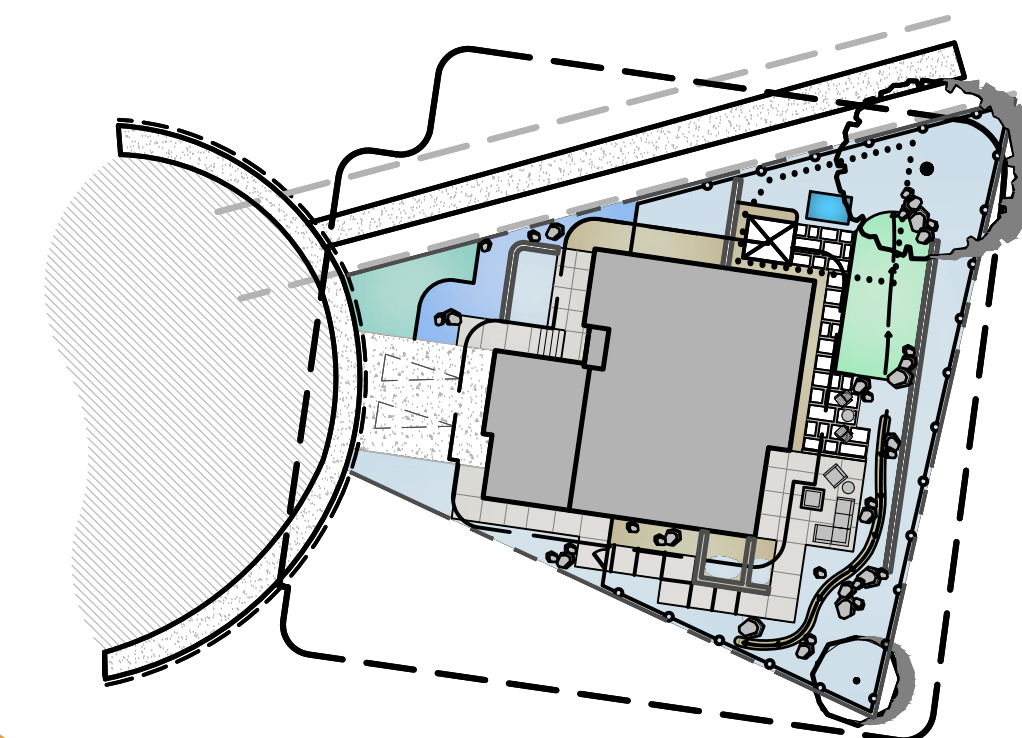

5

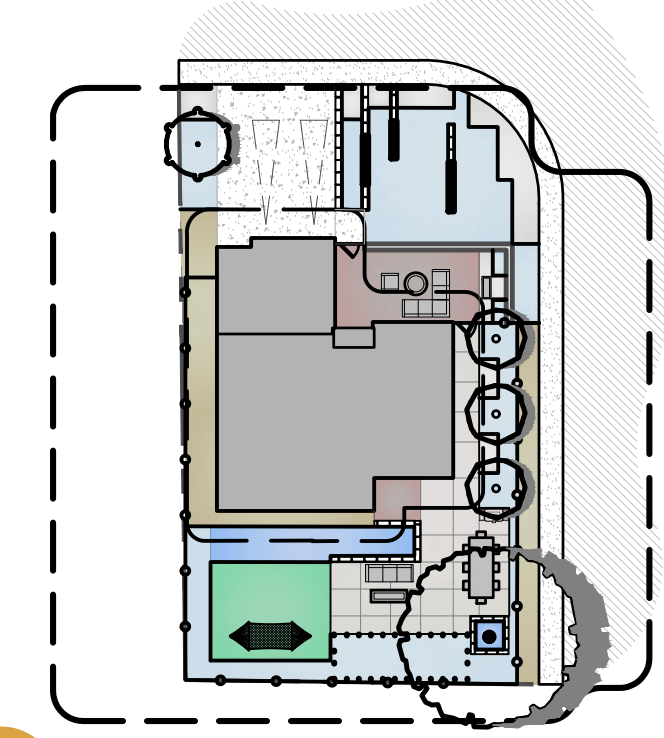

6

# PLANT SCHEDULE

CODE	BOTANICAL NAME	COMMON NAME	ROOT	SIZE	WATER USE	HEIGHT	SPREAD
<b>DECIDUOUS CANOPY TREES</b>							
AC SN	ACER NEGUNDO 'SENSATION'	SENSATION BOX ELDER	B & B	2" CAL	LOW	25'-30'	20'-25'
CA SP	CATALPA SPECIOSA	NORTHERN CATALPA	B & B	2" CAL	LOW	40'-50'	30'-40'
GY DI	GYMNOCLADUS DIOICA 'ESPRESSO'	KENTUCKY COFFEETREE	B & B	2" CAL	LOW	50'-80'	40'-60'
QU MA	QUERCUS MACROCARPA	BURR OAK	B & B	2" CAL	LOW	50'-80'	60'-80'
<b>EVERGREEN TREES</b>							
PI IS	PICEA PUNGENS 'ISELI FASTIGIATE'	FASTIGIATE SPRUCE	B & B	6' HEIGHT	MOD	10'-15'	4'-6'
PI PO	PINUS PONDEROSA	PONDEROSA PINE	B & B	6' HEIGHT	LOW	50'-80'	30'-40'
<b>ORNAMENTAL TREES</b>							
AC HW	ACER TATARICUM 'HOT WINGS'	HOT WINGS TATARIAN MAPLE	B & B	1.5" CAL	LOW	15'-20'	15'-20'
AM AB	AMELANCHIER X GRANDIFLORA 'AUTUMN BRILLIANCE'	AUTUMN BRILLIANCE SERVICEBERRY	B & B	1.5" CAL	LOW	15'-25'	15'-20'
CE PR	CELTIS OCCIDENTALIS 'JFS-KSU1'	PRAIRIE SENTINEL® HACKBERRY	B & B	1.5" CAL	LOW	30'-40'	10'-15'
CR IN	CRATAEGUS CRUS-GALLI INERMIS	THORNLESS COCKSPUR HAWTHORN	B & B	1.5" CAL	LOW	20'-25'	15'-20'
MA AD	MALUS X 'ADIRONDACK'	ADIRONDACK CRABAPPLE	B & B	1.5" CAL	MOD	15'-20'	10'-15'
MA SS	MALUS X 'SPRING SNOW'	SPRING SNOW CRAB APPLE	B & B	1.5" CAL	LOW	15'-25'	20'-25'
PR CH	PRUNUS X VIRGINIANA 'P002'	SUCKER PUNCH CANADA CHOKECHERRY	B & B	1.5" CAL	LOW	20'-25'	15'-20'
<b>DECIDUOUS SHRUBS</b>							
AM RE	AMELANCHIER ALNIFOLIA 'REGENT'	REGENT SERVICEBERRY	CONT.	#5	LOW	7'-8'	7'-8'
AM CA	AMORPHA CANESCENS	LEADPLANT	CONT.	#5	LOW	3'-4'	3'-4'
AR MO	ARONIA MELANOCARPA 'MORTON'	IROQUOIS BEAUTY™ BLACK CHOKEBERRY	CONT.	#5	LOW	4'-5'	2'-3'
CH MI	CHAMAEBATIARIA MILLEFOLIUM	FERNBUSH	CONT.	#5	VERY LOW	4'-5'	5'-6'
CH NN	CHRYSOTHAMNUS NAUSEOSUS NAUCEOSUS	BABY BLUE RABBITBRUSH	CONT.	#5	VERY LOW	1'-2'	2'-3'
CO KE	CORNUS SERICEA 'KELSEY1'	KELSEYI DOGWOOD	CONT.	#5	MOD	2'-3'	2'-3'
CO BA	CORNUS SERICEA 'BAILEY1'	BAYLEY'S RED TWIG DOGWOOD	CONT.	#5	MOD	9'-12'	9'-10'
CY SP	CYTISUS PURGANS 'SPANISH GOLD'	SPANISH GOLD BROOM	CONT.	#5	LOW	3'-4'	5'-6'
CY LE	CYTISUS X 'LENA'	LENA BROOM	CONT.	#5	LOW	2'-3'	3'-4'
EU AL	EUONYMUS ALATUS 'COMPACTUS'	COMPACT BURNING BUSH	CONT.	#5	MOD	7'-8'	7'-8'
FA PA	FALLUGIA PARADOXA	APACHE PLUME	CONT.	#5	VERY LOW	5'-6'	5'-6'
HO DU	HOLIDISCUS DUMOSUS	ROCK SPIREA	CONT.	#5	LOW	5'-6'	5'-6'
JA AM	JAMESIA AMERICANA	WAXFLOWER	CONT.	#5	LOW	7'-8'	5'-6'
LI LO	LIGUSTRUM VULGARE 'LODENSE'	LODENSE PRIVET	CONT.	#5	LOW	2'-3'	3'-4'
PH LI	PHILADELPHUS MICROPHYLLUS	LITTLELEAF MOCKORANGE	CONT.	#5	LOW	5'-6'	4'-5'
PH OP	PHYSOCARPUS OPULIFOLIUS 'DART'S GOLD'	DART'S GOLD NINEBARK	CONT.	#5	LOW	4'-5'	4'-5'
PO FR	POTENTILLA FRUTICOSA	BUSH CINQUEFOIL	CONT.	#5	LOW	2'-3'	2'-3'
PR BE	PRUNUS BESSEYI	WESTERN SAND CHERRY	CONT.	#5	LOW	6'-7'	5'-6'
RI AU	RIBES AUREUM	GOLDEN CURRANT	CONT.	#5	LOW	5'-6'	5'-6'
RO NE	ROSA FLORIBUNDA 'NEARLY WILD'	NEARLY WILD ROSE	CONT.	#5	LOW	2'-3'	2'-3'
SA PU	SALIX PURPUREA 'NANA'	DWARF ARCTIC WILLOW	CONT.	#5	MOD	5'-6'	5'-6'
SH AG	SHEPHERDIA ARGENTEA 'TOTEM'	SILVER TOTEM® BUFFALOBERRY	CONT.	#5	VERY LOW	9'-12'	2'-3'
VI AL	VIBURNUM X RHYTIDOPHYLLOIDES 'ALLEGHANY'	ALLEGHANY VIBURNUM	CONT.	#5	LOW	9'-12'	9'-10'
<b>EVERGREEN SHRUBS</b>							
AR CH	ARCTOSTAPHYLOS X COLORADENSIS 'CHIEFTAIN'	CHIEFTAIN MOCK BEARBERRY MANZANITA	CONT.	#5	LOW	2'-3'	5'-6'
AR PA	ARCTOSTAPHYLOS X COLORADOENSIS 'PANCHITO'	PANCHITO MANZANITA	CONT.	#5	LOW	2'-3'	5'-6'
PI MO	PINUS MUGO 'MOPS'	MUGO PINE	CONT.	#5	LOW	2'-3'	2'-3'
<b>ORNAMENTAL GRASSES</b>							
BO BA	BOUPELLOUA GRACILIS 'BLONDE AMBITION'	BLONDE AMBITION BLUE GRAMA GRASS	CONT.	#1	VERY LOW	2'-3'	1'-2'
FE EB	FESTUCA GLAUCA 'ELIJAH BLUE'	BLUE FESCUE	CONT.	#1	LOW	<1'	<1'
MI VA	MISCANTHUS SINENSIS 'VARIEGATUS'	VARIEGATED MAIDEN GRASS	CONT.	#1	MOD	4'-5'	2'-3'
MU RE	MUHLENBERGIA REVERCHONI 'UNDAUNTED'	UNDAUNTED MUHLY	CONT.	#1	MOD	2'-3'	1'-2'
PA SH	PANICUM VIRGATUM 'SHENANDOAH'	SWITCH GRASS	CONT.	#1	LOW	3'-4'	1'-2'
SC SC	SCHIZACHYRIUM SCOPARIUM	LITTLE BLUESTEM	CONT.	#1	LOW	3'-4'	2'-3'
SC ST	SCHIZACHYRIUM SCOPARIUM 'STANDING OVATION'	STANDING OVATION BLUESTEM GRASS	CONT.	#1	LOW	3'-4'	1'-2'
SP HE	SPOROBOLUS HETEROLEPIS	PRAIRIE DROPSEED	CONT.	#1	LOW	2'-3'	1'-2'
<b>PERENNIALS</b>							
AG RU	AGASTACHE RUPESTRIS	SUNSET HYSOP	CONT.	#1	LOW	1'-2'	2'-3'
AR FR	ARTEMISIA FRIGIDA	FRINGED SAGE	CONT.	#1	VERY LOW	1'-2'	1'-2'
EN PE	ENGELMANNIA PERISTENIA	ENGELMANN'S DAISY	CONT.	#1	LOW	1'-2'	2'-3'
MO BE	MONARDA FISTULOSA	NATIVE BEEBALM	CONT.	#1	LOW	2'-3'	1'-2'
SA RE	SALVIA REPTANS 'P016S'	AUTUMN SAPPHIRE™ SAGE	CONT.	#1	LOW	2'-3'	1'-2'
ZI GR	ZINNIA GRANDIFLORA	ROCKY MOUNTAIN ZINNIA	CONT.	#1	VERY LOW	<1'	1'-2'

# PLANT SCHEDULE LOW-FLAMMABILITY

CODE	BOTANICAL NAME	COMMON NAME	ROOT	SIZE	WATER USE	HEIGHT	SPREAD
<b>DECIDUOUS SHRUBS</b>							
BE TH	BERBERIS THUNBERGII 'ATROPURPUREA'	DWARF RED LEAF JAPANESE BARBERRY	CONT.	#5	LOW	1'-2'	2'-3'
PH CH	PHILADELPHUS LEWISII 'CHEYENNE'	LEWIS MOCK ORANGE	CONT.	#5	LOW	6'-7'	5'-6'
PR PB	PRUNUS BESSEYI PAWNEE BUTTES	CREEPING WESTERN SAND CHERRY	CONT.	#5	LOW	2'-3'	5'-6'
RH GR	RHUS AROMATICA 'GRO-LOW'	GRO-LOW FRAGRANT SUMAC	CONT.	#5	LOW	2'-3'	7'-8'
RH AU	RHUS TRILOBATA 'AUTUMN AMBER'	AUTUMN AMBER SUMAC	CONT.	#5	VERY LOW	1'-2'	5'-6'
SY AL	SYMPHORICARPOS ALBUS	COMMON WHITE SNOWBERRY	CONT.	#5	LOW	3'-4'	3'-4'
<b>EVERGREEN SHRUBS</b>							
EU EG	EUONYMUS FORTUNEI 'EMERALD GAIETY' TM	EMERALD GAIETY EUONYMUS	CONT.	#5	MOD	1'-2'	3'-4'
HE PA	HESPERALOE PARVIFLORA	RED YUCCA	CONT.	#5	VERY LOW	3'-4'	3'-4'
YU FI	YUCCA FILAMENTOSA	ADAM'S NEEDLE	CONT.	#1	LOW	2'-3'	3'-4'
<b>PERENNIALS</b>							
AL MO	ALCHEMILLA MOLLIS	LADY'S MANTLE	CONT.	#1	MOD	1'-2'	1'-2'
AQ CA	AQUILEGIA CAERULEA	ROCKY MOUNTAIN COLUMBINE	CONT.	#1	MOD	1'-2'	1'-2'
AS TU	ASCLEPIAS TUBEROSA	BUTTERFLY MILKWEED	CONT.	#1	LOW	2'-3'	1'-2'
AS LA	ASTER LAEVIS	SMOOTH ASTER	CONT.	#1	LOW	3'-4'	1'-2'
BA AU	BAPTISIA AUSTRALIS	BLUE WILD INDIGO	CONT.	#1	LOW	3'-4'	2'-3'
CE TO	CERASTIUM TOMENTOSUM	SNOW IN SUMMER	CONT.	#1	LOW	1'-2'	1'-2'
CE PL	CERATOSTIGMA PLUMBAGINOIDES	DWARF PLUMBAGO	CONT.	#1	LOW	1'-2'	1'-2'
DE NC	DELOSPERMA BASUTICUM	ICE PLANT	CONT.	#1	LOW	<1'	1'-2'
DI CR	DIASCIA INTEGERRIMA 'P009S'	CORAL CANYON® TWINSBUR	CONT.	#1	LOW	1'-2'	1'-2'
EC PU	ECHINACEA PURPUREA	PURPLE CONEFLOWER	CONT.	#1	LOW	2'-3'	1'-2'
GA AR	GAILLARDIA ARISTATA	NATIVE BLANKET FLOWER	CONT.	#1	LOW	1'-2'	1'-2'
GE ST	GERANIUM VISCOSISSIMUM	STICKY GERANIUM	CONT.	#1	LOW	2'-3'	1'-2'
HE SA	HEUCHERA X 'SNOW ANGEL'	SNOW ANGEL CORAL BELLS	CONT.	#1	MOD	1'-2'	1'-2'
LI LI	LIATRIS LIGULISTYLIS	MEADOW BLAZING-STAR	CONT.	#1	LOW	2'-3'	1'-2'
MI MU	MIRABILIS MULTIFLORA	DESERT FOUR O'CLOCK	CONT.	#1	VERY LOW	2'-3'	3'-4'
PE DI	PENSTEMON DIGITALIS 'HUSKER RED'	HUSKER RED BEARDTONGUE	CONT.	#1	LOW	2'-3'	1'-2'
PE PP	PENSTEMON MEXICALI 'PIKE'S PEAK PURPLE'	PIKES PEAK PURPLE PENSTEMON	CONT.	#1	LOW	1'-2'	<1'
PE ST	PENSTEMON STRICTUS	ROCKY MOUNTAIN PENSTEMON	CONT.	#1	LOW	1'-2'	1'-2'
RU FU	RUDBECKIA FULGIDA 'GOLDSTRUM'	BLACK-EYED SUSAN	CONT.	#1	LOW	1'-2'	1'-2'
SA SP	SAPONARIA OCYMOIDES 'SPLENDENS'	ROCK SOAPWORT	CONT.	#1	LOW	<1'	1'-2'
SE RU	SEDUM RUPESTRE 'ANGELINA'	ANGELINA STONECROP	CONT.	#1	LOW	<1'	2'-3'
SE AJ	SEDUM X 'AUTUMN JOY'	AUTUMN JOY SEDUM	CONT.	#1	LOW	1'-2'	1'-2'
SO BA	SOLIDAGO X 'GOLDKIND'	GOLDEN BABY GOLDENROD	CONT.	#1	LOW	1'-2'	1'-2'
VE SN	VERONICA SNOWMASS	SNOWMASS BLUE-EYED SPEEDWELL	CONT.	#1	LOW	<1'	1'-2'
ZA GA	ZAUSCHNERIA GARRETTII 'PWWG01S'	ORANGE CARPET® HUMMINGBIRD TRUMPET	CONT.	#1	LOW	1'-2'	1'-2'

**NOTES:**

- SHRUBS, ORNAMENTAL GRASSES, AND PERENNIAL SIZING MAY BE REDUCED TO SAVE ON COST OF INSTALLATION.
- SHRUB BED PLANTING DESIGN SHOULD ACHIEVE MINIMUM 50% COVERAGE WITHIN 2-3 GROWING SEASONS
- FIRE SMART PLANT SCHEDULE INCLUDES PLANTS WITH RATING OF 7 OR GREATER AS DESIGNATED BY IDAHO LOW-FLAMMABILITY <<https://idahofirewise.org/firewise-landscapes/firewise-plant-materials/>>

# 6 CORNER LOT

**KEY CHARACTERISTICS:** MODERN, ORGANIZED PLANTING SCHEMES, STAGGERED, CLEAN BORDERS, VARIED TEXTURES & COLORS

ALTERNATIVES TO CEDAR SCREEN FENCE TO CREATE PRIVATE SPACE



DECORATIVE STONE EDGING ADDS INTEREST IN ALL SEASONS



OUTDOOR LIVING SPACES



FREESTANDING CAST-IN-PLACE, DECORATIVE CONCRETE WALL PRECEDENT

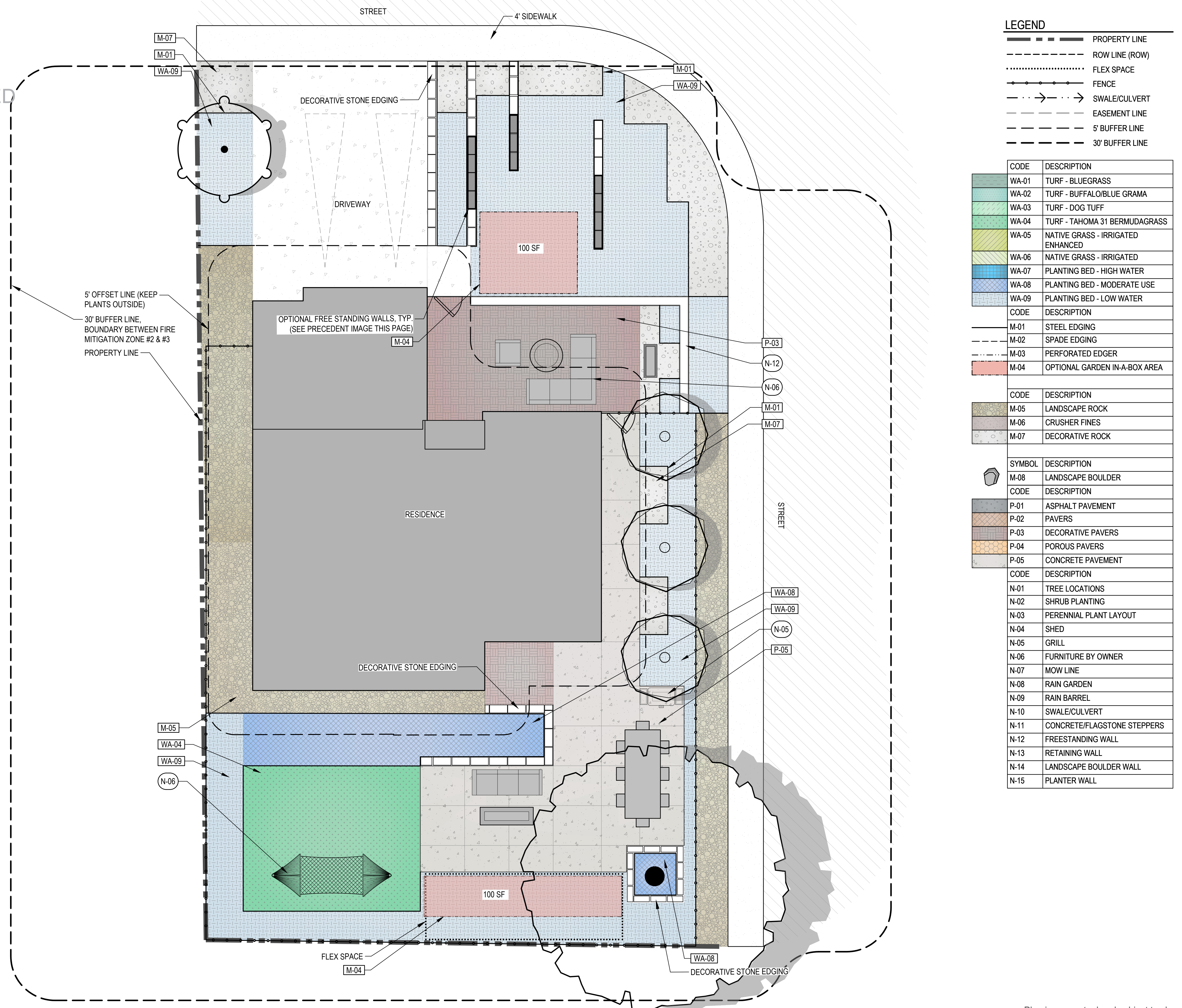

**LEGEND**

- — — — — PROPERTY LINE
- - - - - ROW LINE (ROW)
- ..... FLEX SPACE
- — — — — FENCE
- — — — — SWALE/CULVERT
- - - - - EASEMENT LINE
- - - - - 5' BUFFER LINE
- - - - - 30' BUFFER LINE

CODE	DESCRIPTION
WA-01	TURF - BLUEGRASS
WA-02	TURF - BUFFALO/BLUE GRAMA
WA-03	TURF - DOG TUFF
WA-04	TURF - TAHOMA 31 BERMUDAGRASS
WA-05	NATIVE GRASS - IRRIGATED ENHANCED
WA-06	NATIVE GRASS - IRRIGATED
WA-07	PLANTING BED - HIGH WATER
WA-08	PLANTING BED - MODERATE USE
WA-09	PLANTING BED - LOW WATER
CODE DESCRIPTION	
M-01	STEEL EDGING
M-02	SPADE EDGING
M-03	PERFORATED EDGER
M-04	OPTIONAL GARDEN IN-A-BOX AREA
CODE DESCRIPTION	
M-05	LANDSCAPE ROCK
M-06	CRUSHER FINES
M-07	DECORATIVE ROCK
SYMBOL DESCRIPTION	
M-08	LANDSCAPE BOULDER
CODE DESCRIPTION	
P-01	ASPHALT PAVEMENT
P-02	PAVERS
P-03	DECORATIVE PAVERS
P-04	POROUS PAVERS
P-05	CONCRETE PAVEMENT
CODE DESCRIPTION	
N-01	TREE LOCATIONS
N-02	SHRUB PLANTING
N-03	PERENNIAL PLANT LAYOUT
N-04	SHED
N-05	GRILL
N-06	FURNITURE BY OWNER
N-07	MOW LINE
N-08	RAIN GARDEN
N-09	RAIN BARREL
N-10	SWALE/CULVERT
N-11	CONCRETE/FLAGSTONE STEPPERS
N-12	FREESTANDING WALL
N-13	RETAINING WALL
N-14	LANDSCAPE BOULDER WALL
N-15	PLANTER WALL

Plan is conceptual and subject to change.

**PLANT SCHEDULE**

CODE	QTY	COMMON NAME
<b>DECIDUOUS CANOPY TREES</b>		
AC SN	1	SENSATION BOX ELDER
<b>ORNAMENTAL TREES</b>		
CE PR	1	PRAIRIE SENTINEL® HACKBERRY
MA AD	3	ADIRONDACK CRABAPPLE
<b>DECIDUOUS SHRUBS</b>		
AR MO	5	IROQUOIS BEAUTY™ BLACK CHOKEBERRY
BE TH	4	DWARF RED LEAF JAPANESE BARBERRY
CO KE	8	KELSEYI DOGWOOD
CY LE	2	LENA BROOM
CY SP	1	SPANISH GOLD BROOM
LI LO	4	LODENSE PRIVET
PH OP	4	DART'S GOLD NINEBARK
RH GR	3	GRO-LOW FRAGRANT SUMAC
SA PU	3	DWARF ARCTIC WILLOW
<b>EVERGREEN SHRUBS</b>		
AR CH	1	CHIEFTAIN MOCK BEARBERRY
PI MO	4	MANZANITA MUGO PINE
<b>ORNAMENTAL GRASSES</b>		
MU RE	10	UNDAUNTED MUHLY
SC SC	12	LITTLE BLUESTEM
SC ST	6	STANDING OVATION BLUESTEM GRASS
SP HE	6	PRAIRIE DROPSIED
<b>PERENNIALS</b>		
AQ CA	6	ROCKY MOUNTAIN COLUMBINE
BA AU	5	BLUE WILD INDIGO
CE PL	4	DWARF PLUMBAGO
CE TO	3	SNOW IN SUMMER
DE NC	6	ICE PLANT
DI CR	3	CORAL CANYON® TWINSPUR
EC PU	14	PURPLE CONEFLOWER
ER SU	3	SULPHUR FLOWER
LI LI	4	MEADOW BLAZING-STAR
PE ST	12	ROCKY MOUNTAIN PENSTEMON
SA RE	12	AUTUMN SAPPHIRE™ SAGE
SE AJ	3	AUTUMN JOY SEDUM
SE RU	3	ANGELINA STONECROP
VE SN	5	SNOWMASS BLUE-EYED SPEEDWELL

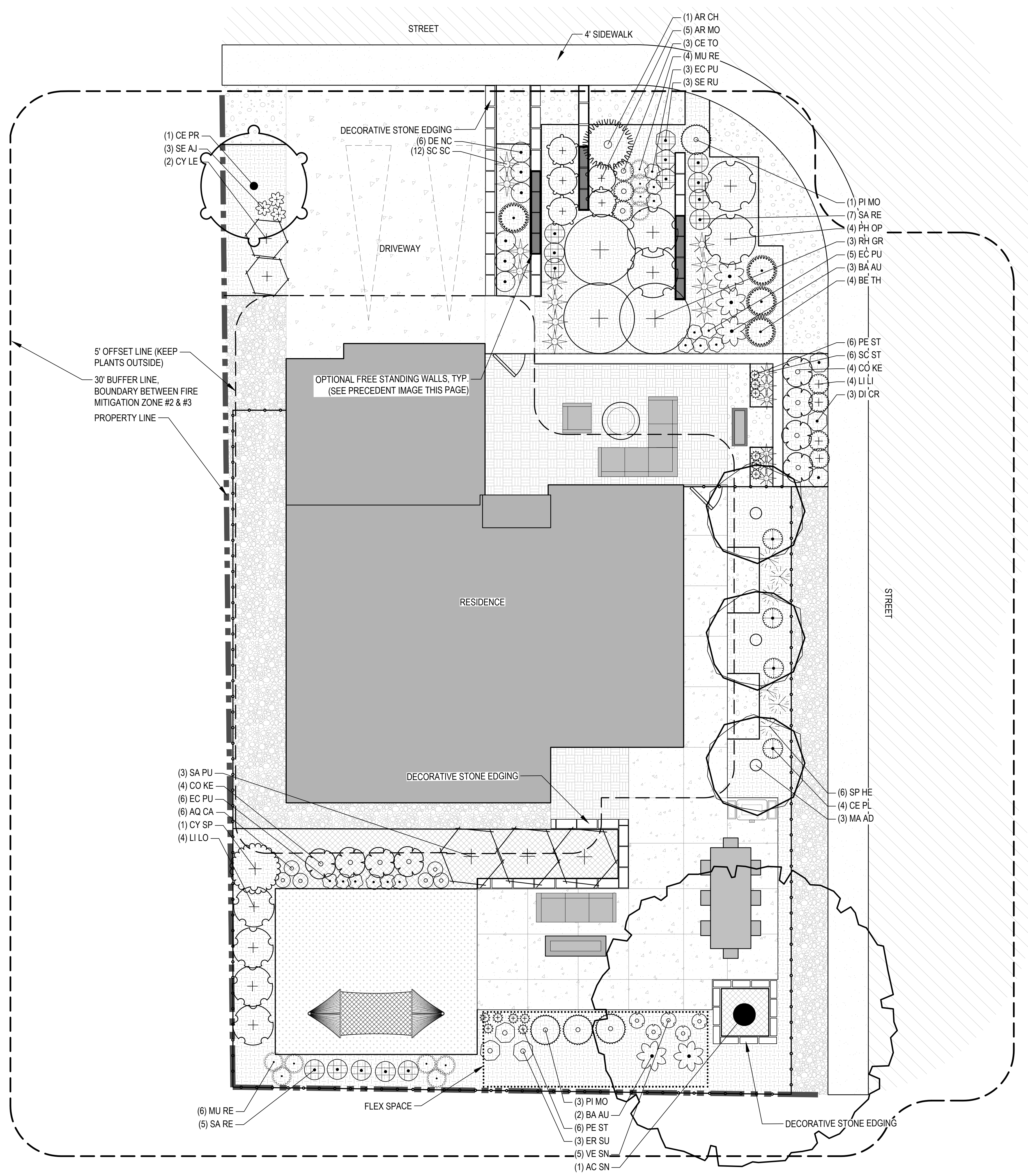

**LEGEND**

---	PROPERTY LINE
- - - -	ROW LINE (ROW)
.....	FLEX SPACE
—●—●—●—	FENCE
—→→→→—	SWALE/CULVERT
- - - -	EASEMENT LINE
- - - -	5' BUFFER LINE
- - - -	30' BUFFER LINE

SYMBOL	DESCRIPTION
[Symbol]	TURF - BLUEGRASS
[Symbol]	TURF - BUFFALO/BLUE GRAMA
[Symbol]	TURF - DOG TUFF
[Symbol]	TURF - TAHOMA 31 BERMUDAGRASS
[Symbol]	NATIVE GRASS - IRRIGATED ENHANCED
[Symbol]	NATIVE GRASS - IRRIGATED
[Symbol]	PLANTING BED - HIGH WATER
[Symbol]	PLANTING BED - MODERATE USE
[Symbol]	PLANTING BED - LOW WATER
CODE	DESCRIPTION
M-01	STEEL EDGING
M-02	SPADE EDGING
M-03	PERFORATED EDGER
M-04	OPTIONAL GARDEN IN-A-BOX AREA
SYMBOL	DESCRIPTION
[Symbol]	LANDSCAPE BOULDER
[Symbol]	LANDSCAPE ROCK
[Symbol]	CRUSHER FINES
[Symbol]	DECORATIVE ROCK

Plan is conceptual and subject to change.



- NOTES:
1. THERE SHALL BE NO EXPOSED SHARP/ JAGGED EDGES.
  2. CONTRACTOR SHALL INSTALL STAKES AS REQUIRED BY THE MANUFACTURER.
  3. ENSURE POSITIVE DRAINAGE.

### 1 METAL EDGER

SCALE: 1" = 1'-0"

- 1 FINISHED GRADE, TOP OF SOD THATCH LAYER AND TOP OF MULCH OR CRUSHER FINES SHALL BE FLUSH WITH TOP OF EDGER
- 2 AMENDED SOIL PER SPECIFICATIONS
- 3 METAL EDGER, DRILL (16) 1/2" DIAMETER HOLES 1" ON CENTER MINIMUM AT ALL LOW POINTS OR POORLY DRAINING AREAS IN ORDER TO ENSURE ADEQUATE DRAINAGE
- 4 EDGER STAKE
- 5 SUBGRADE COMPACTED TO 95% STANDARD PROCTOR DENSITY

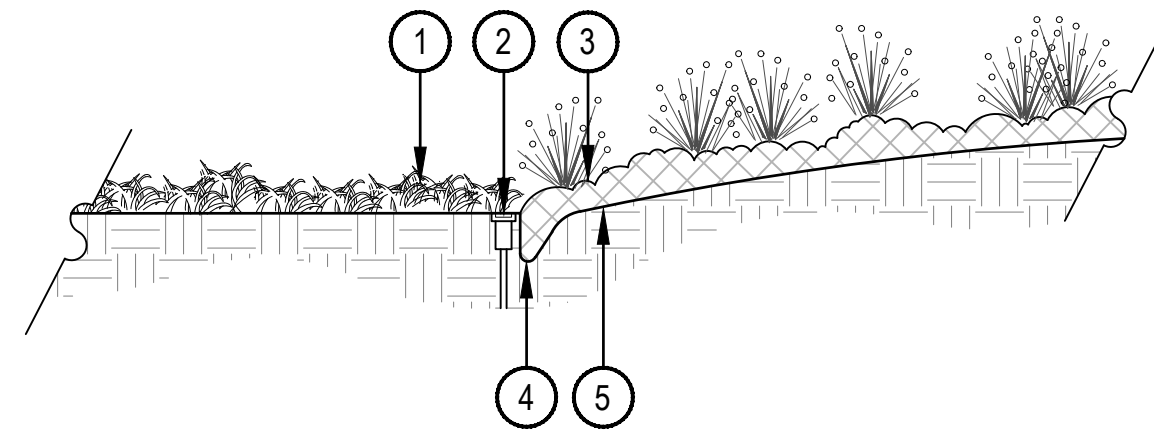

- NOTE:
1. THIS EDGER DETAIL IS BEST FOR NATURALIZED OR INFORMAL LANDSCAPE AREAS THAT DON'T REQUIRE A HARD CLEAN EDGE AT PLANTING BEDS. SEE PLANS FOR RECOMMENDED LOCATIONS.

### 2 SPADE CUT EDGE

SCALE: 1/2" = 1'-0"

### 3 LANDSCAPE BOULDER

SCALE: 3/4" = 1'-0"

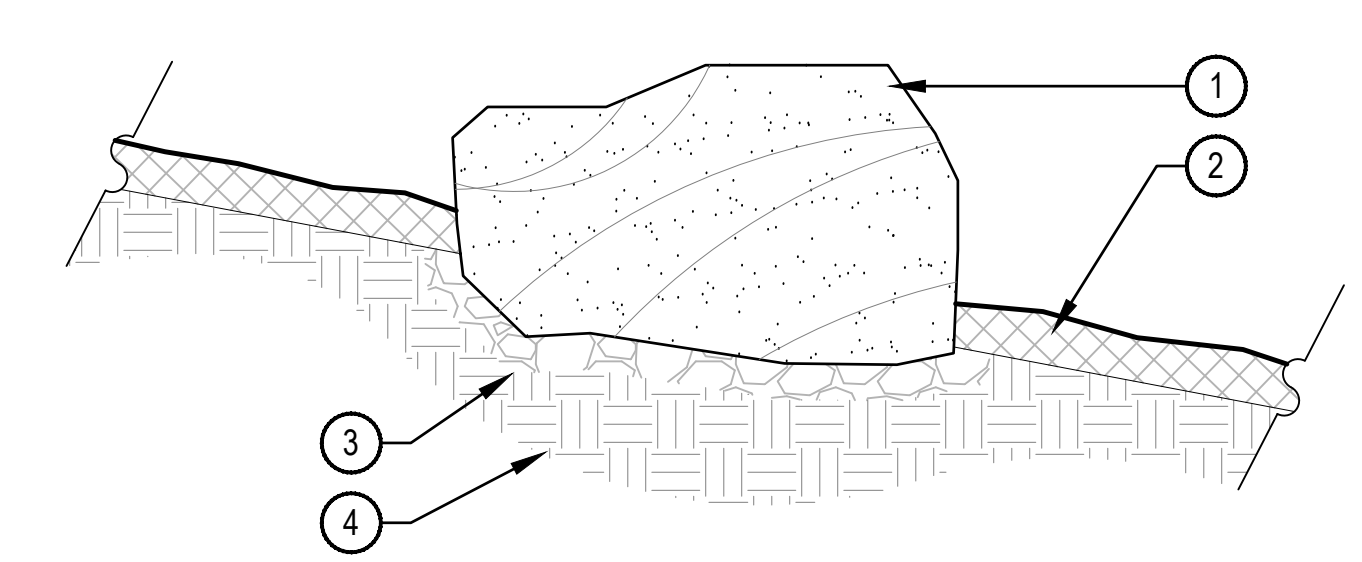

BOULDER SIZE	
ITEM	SIZE
SMALL BOULDER	18"-30" DIAMETER X 18" MINIMUM DEPTH
MEDIUM BOULDER	30 - 48" DIAMETER X 24" MINIMUM DEPTH
LARGE BOULDER	48 - 60" DIAMETER X 32" MINIMUM DEPTH

- NOTES:
1. THESE ARE FREE STANDING BOULDERS ONLY. BOULDERS ASSOCIATED WITH THE BOULDER RETAINING WALLS, PARK ENTRY SIGNS AND INTERPRETIVE SIGNS ARE NOT INCLUDED IN THIS COUNT.
  2. THE OWNERS REPRESENTATIVE SHALL APPROVE LOCATIONS AND SIZES OF ALL BOULDERS PRIOR TO PLACING.
  3. CONTRACTOR SHALL SUBMIT SAMPLE OR PHOTOS FOR APPROVAL.

- 1 BOULDER, NATURALLY SET BOULDER SO THAT A MINIMUM 1/4 OF BOULDER IS BELOW FINISH GRADE
- 2 SPECIFIED MULCH, DECOMPOSED GRANITE, OR COBBLE, REFER TO PLAN
- 3 3" MINIMUM ROAD BASE COMPACTED TO 95% OF STANDARD PROCTOR DENSITY
- 4 UNDISTURBED GRADE

- PRUNING NOTES:
1. ALL PRUNING SHALL COMPLY WITH ANSI A300 STANDARDS.
  2. DO NOT HEAVILY PRUNE THE TREE AT PLANTING. PRUNE ONLY CROSSOVER LIMBS, CO-DOMINANT LEADERS AND BROKEN BRANCHES. SOME INTERIOR TWIGS AND LATERAL BRANCHES MAY BE PRUNED. HOWEVER, DO NOT REMOVE THE TERMINAL BUDS OF BRANCHES THAT EXTEND TO THE EDGE OF THE CROWN.
- STAKING NOTES:
1. STAKING OF TREES IS RECOMMENDED PER THE FOLLOWING SCHEDULE, THEN REMOVE AT END OF FIRST GROWING SEASON.
    - a. 1-1/2" CALIPER SIZE - MIN. 1 STAKE ON SIDE OF PREVAILING WIND (GENERALLY N.W. SIDE).
    - b. 1-1/2" - 3" CALIPER SIZE - MIN. 2 STAKES - ONE ON N.W. SIDE, ONE ON S.W. SIDE (OR PREVAILING WIND SIDE AND 180° FROM THAT SIDE).
    - c. 3" CALIPER SIZE AND LARGER - 3 STAKES PER DIAGRAM.
  2. WIRE OR CABLE SHALL BE MIN. 12 GAUGE, TIGHTEN WIRE OR CABLE ONLY ENOUGH TO KEEP FROM SLIPPING. ALLOW FOR SOME TRUNK MOVEMENT. NYLON STRAPS SHALL BE LONG ENOUGH TO ACCOMMODATE 1-1/2" OF GROWTH AND BUFFER ALL BRANCHES FROM WIRE.

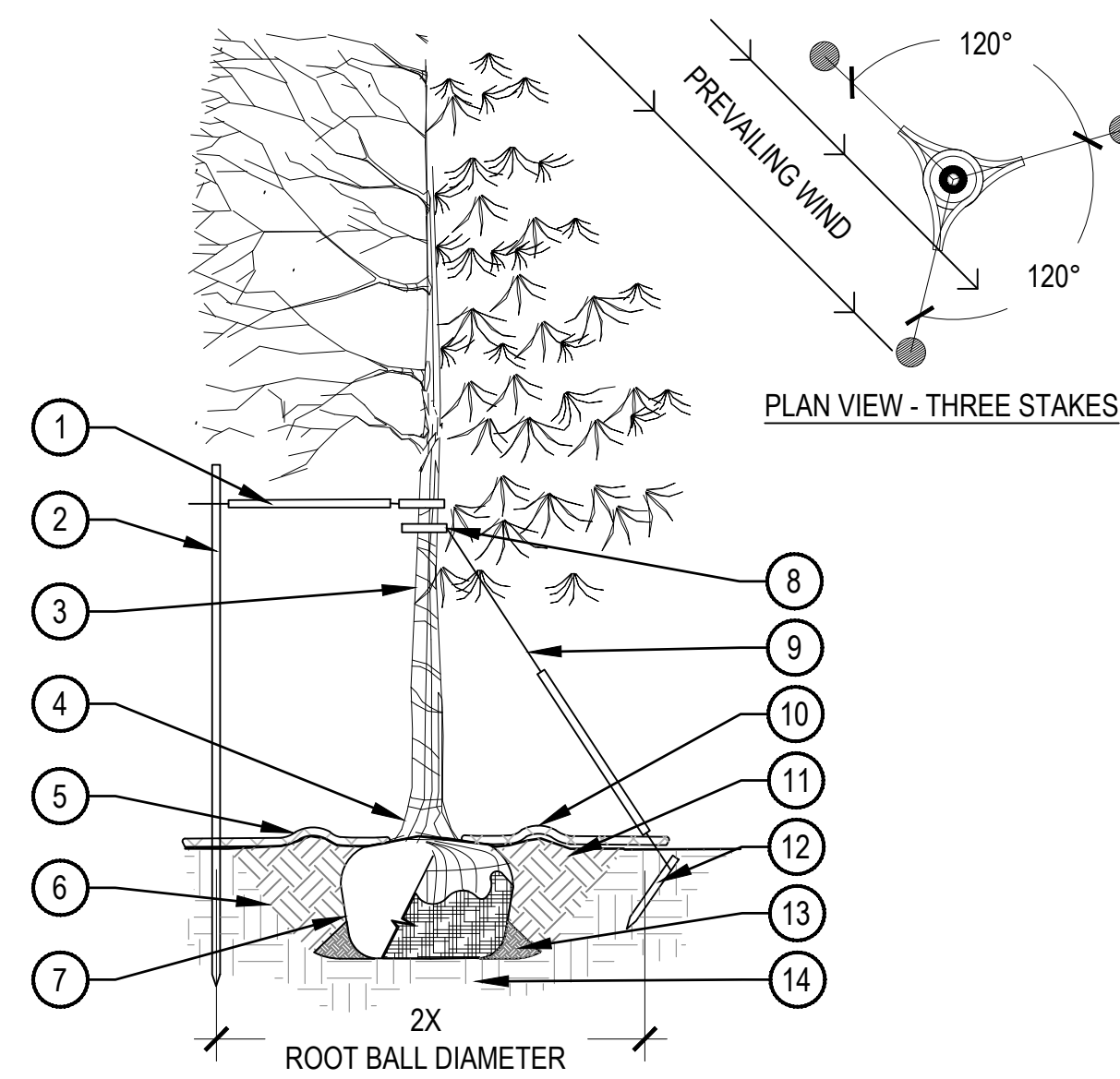

- 1 PLACE MINIMUM 1/2" PVC PIPE AROUND EACH WIRE, EXPOSED WIRE SHALL BE MAXIMUM 2" EACH SIDE
- 2 6'-0" UNTREATED WOOD POST, MINIMUM 1.5" DIAMETER, ALL SHALL BE DRIVEN OUTSIDE ROOTBALL AND IN UNDISTURBED SOIL
- 3 TREE WRAP TO BE INSTALLED ONLY FROM OCTOBER 1 THROUGH APRIL 30, DECIDUOUS ONLY, WRAP FROM BASE OF TRUNK TO BOTTOM LIMB
- 4 PLANT TREE SO THAT TOP MOST MAJOR ROOT IS 1"-2" ABOVE FINISHED GRADE
- 5 2'-0" RADIUS MULCH RING, CENTERED ON TRUNK, 3" DEPTH. DO NOT PLACE MULCH IN CONTACT WITH TREE TRUNK, FINISHED GRADE REFERENCES TOP OF MULCH
- 6 1:1 SLOPE ON SIDES OF PLANTING HOLE
- 7 ROPES AT TOP OF ROOTBALL SHALL BE CUT, REMOVE TOP 1/3 OF BURLAP, NON-BIODEGRADABLE MATERIAL SHALL BE TOTALLY REMOVED
- 8 GROMMETED NYLON STRAPS
- 9 GALVANIZED WIRE, MINIMUM 12 GAUGE CABLE, TWIST WIRE ONLY TO KEEP FROM SLIPPING
- 10 4-6" HIGH WATER SAUCER IN NON-TURF AREAS
- 11 BACKFILL WITH BLEND OF EXISTING SOIL AND A MAXIMUM 20%, BY VOLUME, ORGANIC MATERIAL, WATER THOROUGHLY WHEN BACKFILLING
- 12 2'-0" STEEL T-POST, ALL SHALL BE DRIVEN BELOW GRADE AND OUTSIDE ROOTBALL IN UNDISTURBED SOIL
- 13 PLACE SOIL AROUND ROOT BALL FIRMLY, DO NOT COMPACT OR TAMP, SETTLE SOIL WITH WATER TO FILL ALL AIR POCKETS
- 14 PLACE ROOT BALL ON UNDISTURBED SOIL TO PREVENT SETTLEMENT

### 4 TREE PLANTING DETAIL

SCALE: 3/16" = 1'-0"

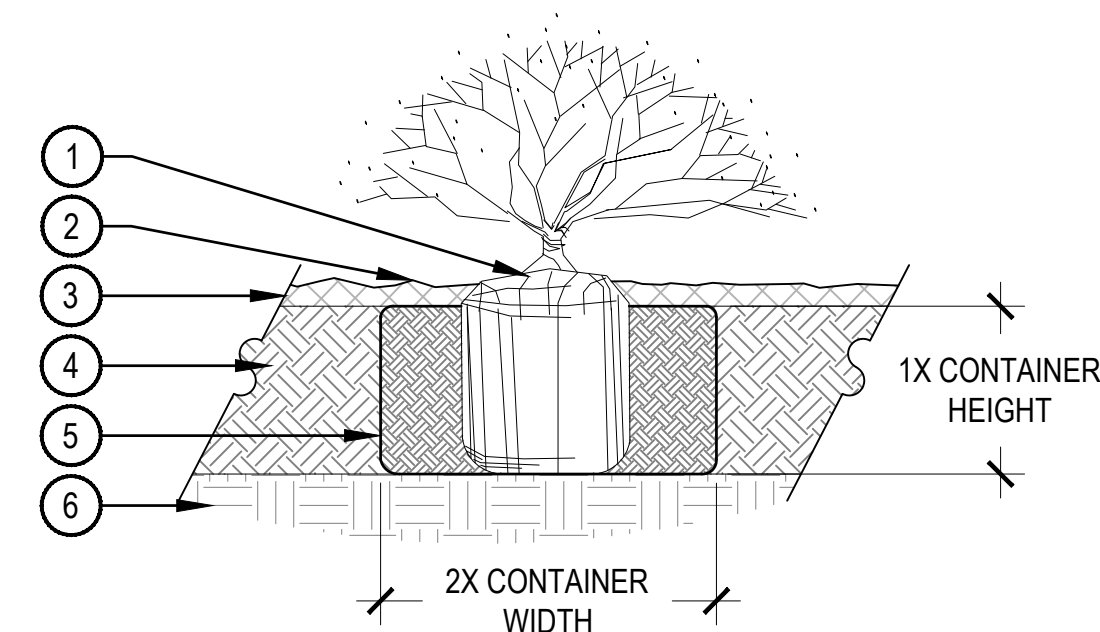

- NOTE:
1. CARE SHOULD BE TAKEN NOT TO DAMAGE THE SHRUB OR ROOT-BALL WHEN REMOVING IT FROM ITS CONTAINER.
  2. DIG PLANT PIT TWICE AS WIDE AND AS HIGH AS THE CONTAINER.
  3. PRUNE ALL DEAD OR DAMAGED WOOD PRIOR TO PLANTING, DO NOT PRUNE MORE THAN 20% OF LIMBS.

- BACKFILL AMENDMENT NOTES:
4. **MODERATE OR HIGH WATER NON-NATIVE PLANTS** - IF PLANTING BED AREA IS AMENDED THROUGHOUT WITH ORGANIC COMPOST, ADDITIONAL COMPOST AMENDMENT IN BACKFILL IS NOT REQUIRED.
  5. **LOW WATER NATIVE PLANTS** - AMEND PLANTING PIT WITH 3/8" MINUS PEA GRAVEL (SQUEEGEE) UP TO 1/4 OF THE TOTAL VOLUME OF THE PLANTING PIT. MIX COMPLETELY WITH EXISTING SOIL DUG FROM THE PLANTING PIT BEFORE BACKFILL AND PLANTING. COMPOST AMENDMENT CAN BE MINIMIZED OR ELIMINATED IN AREAS WHERE ALL NATIVE PLANTS

### 6 SHRUB PLANTING

SCALE: 1 1/2" = 1'-0"

- 1 SET SHRUB ROOT-BALL 1" HIGHER THAN FINISH GRADE
- 2 FINISH GRADE (TOP OF MULCH)
- 3 MULCH
- 4 TILL IN SPECIFIED SOIL AMENDMENT TO A DEPTH OF 8" IN BED
- 5 BACKFILLED AMENDED SOIL
- 6 UNDISTURBED SOIL

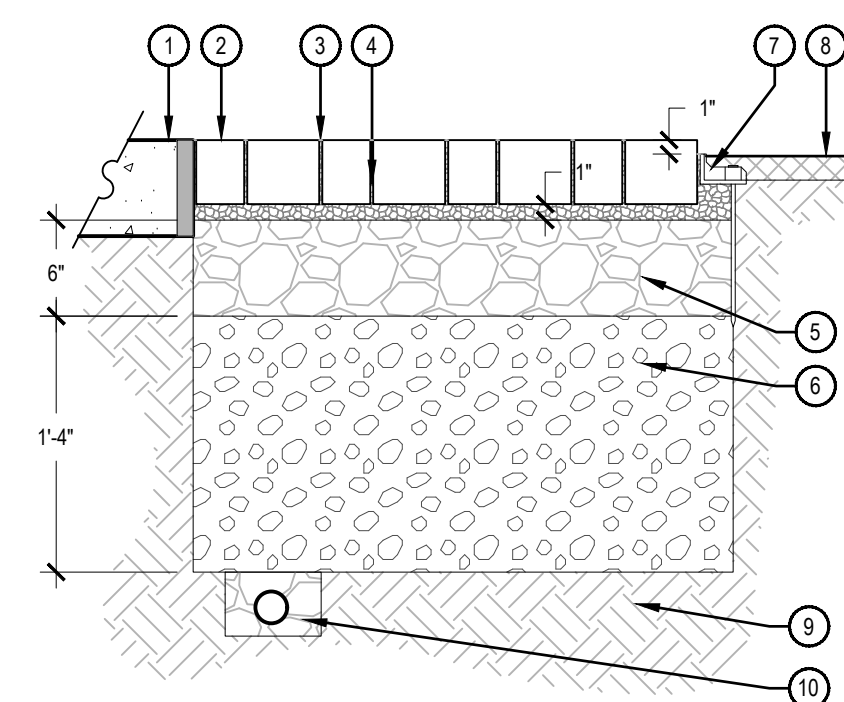

- NOTES:
1. PROVIDE SMOOTH TRANSITION BETWEEN PLANK PAVING AND ADJACENT SURFACES.
  2. PROVIDE POSITIVE DRAINAGE FROM ALL PAVING SURFACES.

### 7 PERMEABLE PAVING

SCALE: 1" = 1'-0"

- 1 ADJACENT PAVING, REFER TO LANDSCAPE PLANS
- 2 ECO-LINE, UNILOCK PERMEABLE PAVERS, REFER TO MATERIALS SCHEDULE, SHEET LS-100
- 3 PERMEABLE JOINT OPENING AGGREGATE, 3/8" INCH
- 4 1" PERMEABLE SETTING BED AGGREGATE
- 5 6" MIN PERMEABLE BASE AGGREGATE
- 6 16" MIN PERMEABLE SUBBASE AGGREGATE
- 7 SEK SUREBOND SNAP EDGE PAVER EDGING WITH 10" METAL STAKE, OR APPROVED EQUAL
- 8 ADJACENT LANDSCAPE, REFER TO PLANS
- 9 SUBGRADE MATERIAL, MIN 5% SLOPE TO DRAIN, RE: CIVIL
- 10 PVC UNDERDRAIN PIPE

### 8 COBBLE SWALE

SCALE: 1/4" = 1'-0"

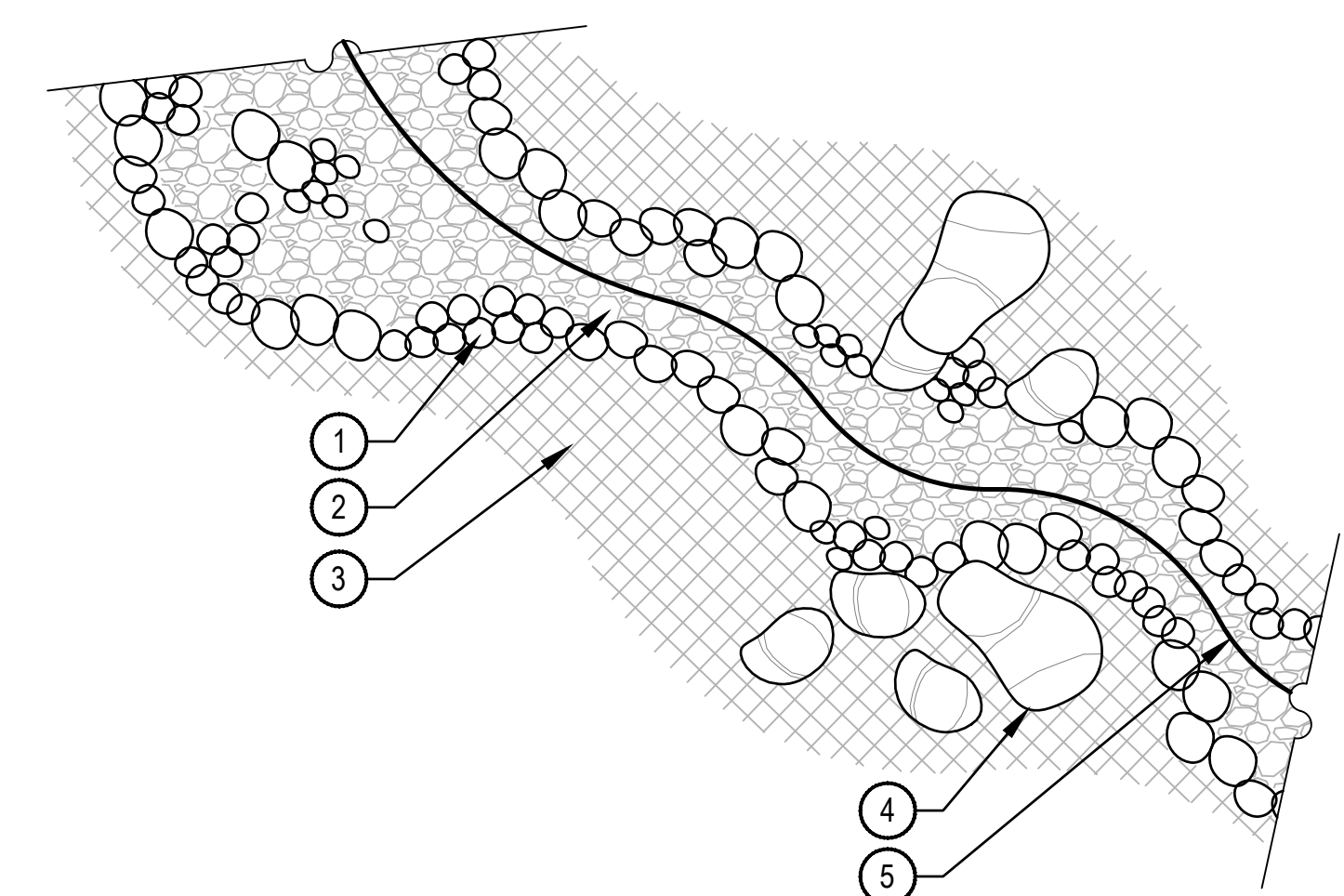

- NOTES:
1. THERE SHALL BE NO STEEL EDGER BETWEEN COBBLE SWALE AND LANDSCAPE BED.
  2. SPECIFIED WEED BARRIER FABRIC SHALL BE INSTALLED UNDER ALL COBBLE. NO WEED BARRIER FABRIC SHALL BE VISIBLE.

- 1 5"-12" COBBLE, SET ON EDGE OF SWALE AS WELL AS IN A FEW INTERIOR AREAS TO CREATE A LOOSE, NATURALISTIC BORDER AS SHOWN
- 2 2"-4" COBBLE, SET IN INTERIOR AREAS OF SWALE, 4"-5" DEPTH
- 3 ADJACENT LANDSCAPE, REFER TO LANDSCAPE PLANS
- 4 BOULDERS SET IN AND AROUND SWALE, REFER TO DETAIL X, SHEET L-XXX
- 5 DO NOT IMPEDE FLOW AT BOTTOM OF SWALE

### 5 PERENNIAL PLANT LAYOUT

SCALE: 1" = 1'-0"

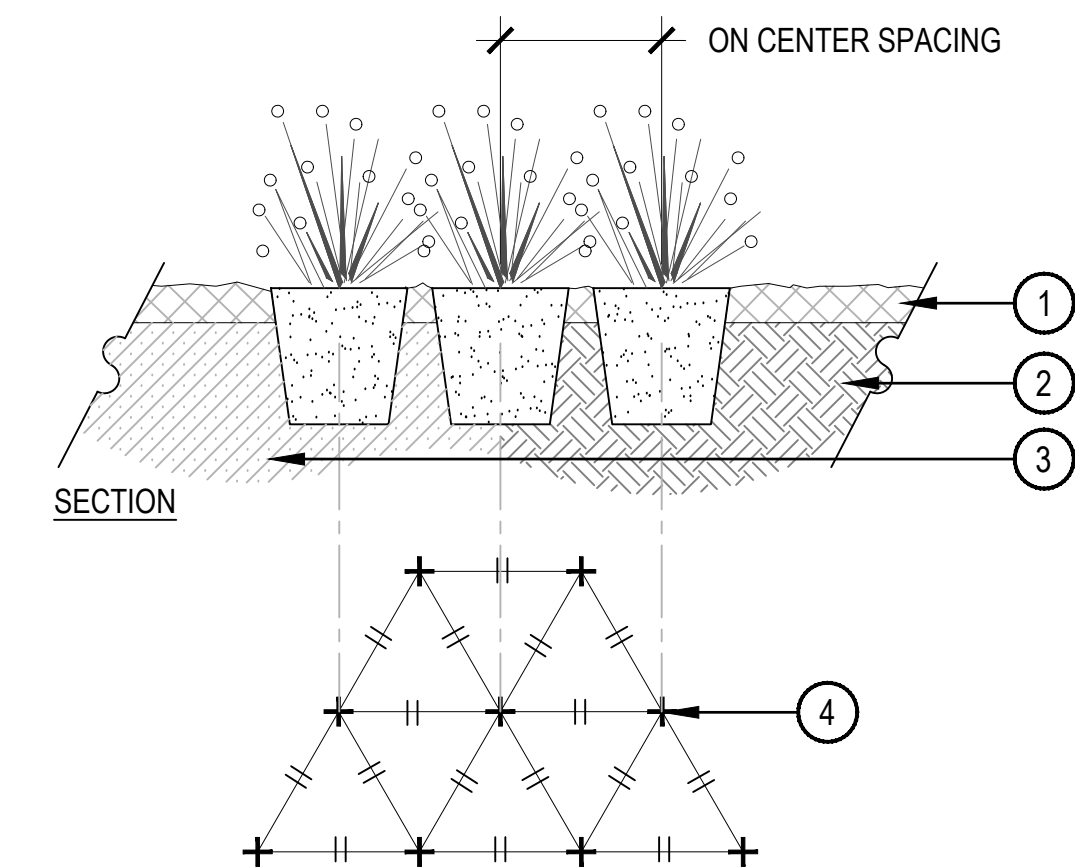

- 1 SPECIFIED MULCH, REFER TO LANDSCAPE NOTES SECTION
- 2 **MODERATE OR HIGH WATER NON-NATIVE PLANTS** - AMENDED PLANTING BED TILLED TO A DEPTH OF 6" WITH ORGANIC COMPOST AS RECOMMENDED IN THE LANDSCAPE NOTES SECTION OR AS VERIFIED WITH SOIL TESTING.
- 3 **LOW WATER NATIVE PLANTS** - AMEND PLANTING PIT WITH 3/8" MINUS PEA GRAVEL (SQUEEGEE) UP TO 1/4 OF THE TOTAL VOLUME OF THE PLANTING PIT. MIX COMPLETELY WITH EXISTING SOIL DUG FROM THE PLANTING PIT. COMPOST AMENDMENT CAN BE MINIMIZED OR ELIMINATED IN AREAS WHERE ALL NATIVE PLANTS ARE USED.
- 4 CENTER OF PLANT

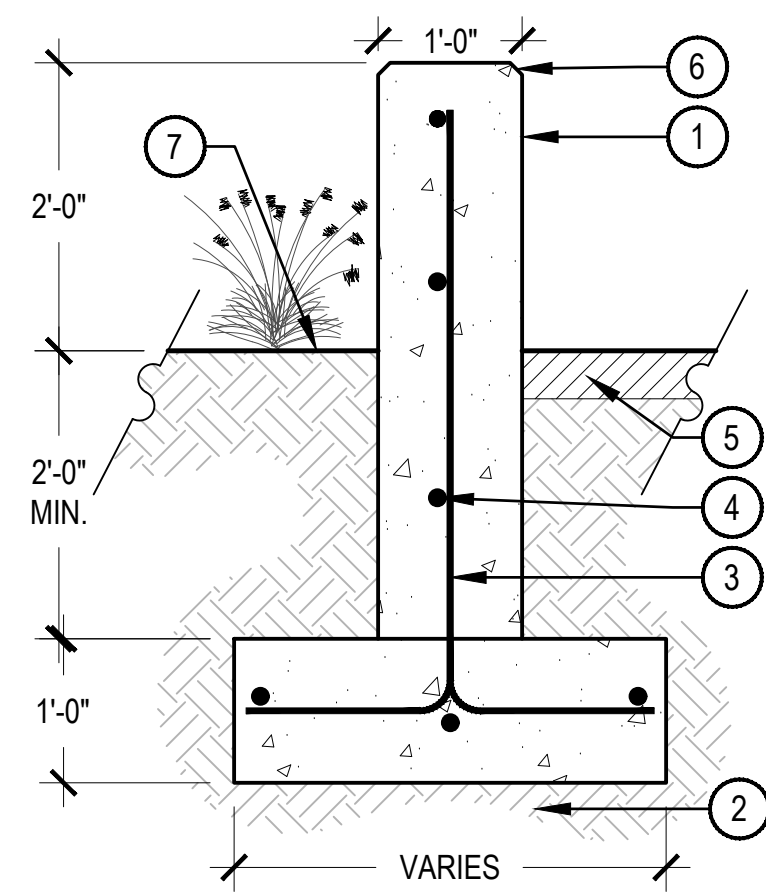

- 1 STANDARD GRAY CONCRETE WITH SMOOTH ARCHITECTURAL FINISH. OPTION TO USE INTEGRAL COLOR AND/OR BOARD FORM FINISH
- 2 COMPACTED SUBGRADE
- 3 #4 CONTINUOUS REBAR, 18" ON CENTER, ALTERNATE HOOKS ON VERTICAL
- 4 #4 CONTINUOUS REBAR, DOWN LENGTH OF FOOTER
- 5 FINISH MATERIAL VARIES, REFER TO PLAN LAYOUT
- 6 1" CHAMFER ON ALL EXPOSED EDGES
- 7 ADJACENT LANDSCAPE BED

- NOTES:
1. ALL CONCRETE SHALL HAVE A MINIMUM COMPRESSIVE STRENGTH OF 5,000 PSI AT 28 DAYS.
  2. MINIMUM BURY DEPTH ON ALL REBAR SHALL BE 2-1/2".
  3. VERTICAL CONTROL JOINTS SHALL BE 10' ON CENTER WITH EXPANSION JOINTS 50' ON CENTER, UNLESS OTHERWISE NOTED.
  4. VERTICAL FACES OF WALL SHALL BE PLUMB, WITH NO INCONSISTENCIES GREATER THAN 1/4" IN 10'-0" MEASURED IN ANY DIRECTION ALONG THE FACE OF THE WALL.
  5. WALL SHALL BE INSTALLED SO HORIZONTAL CURVES ARE SMOOTH AND FREE-FLOWING AS SHOWN ON PLANS.
  6. THIS DETAIL IS CONCEPTUAL AND FOR REFERENCE ONLY. SITE WALLS REQUIRE SITE SPECIFIC ENGINEERING DESIGN.

### 1 CAST IN PLACE CONCRETE WALL

SCALE: 3/4" = 1'-0"

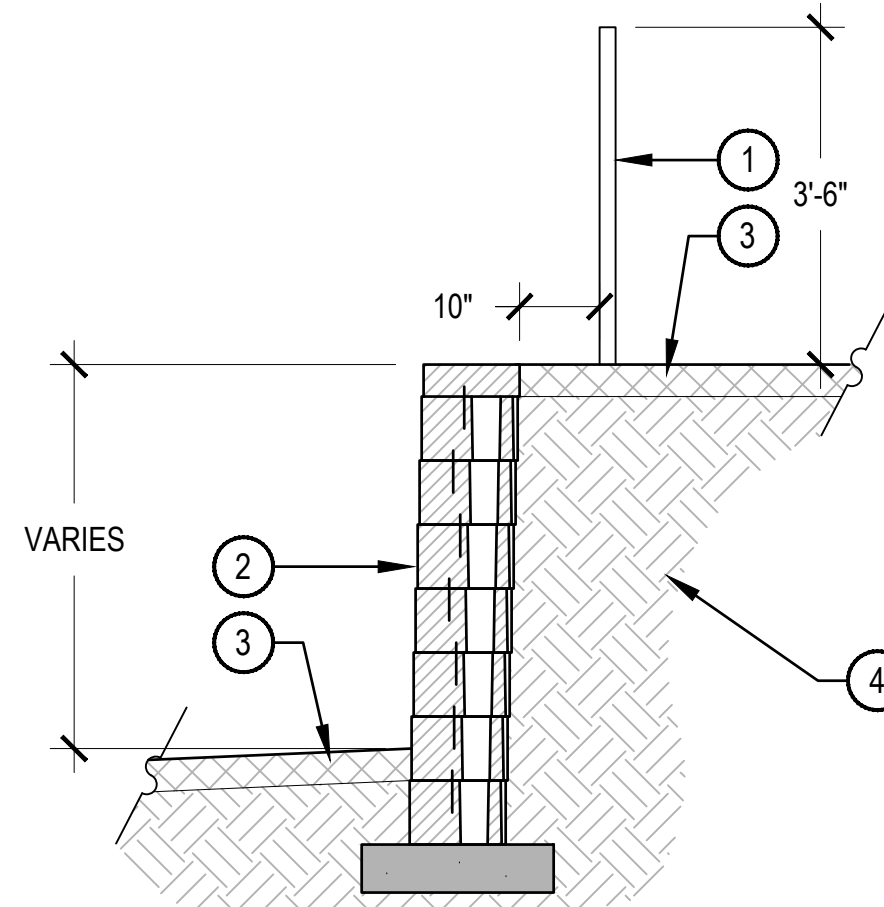

- 1 BARRIER RAILING, MOUNT IN LANDSCAPE. TO BE INSTALLED WHEN RETAINING WALL IS 29" OR TALLER
- 2 BLOCK RETAINING WALL
- 3 ADJACENT LANDSCAPE
- 4 SUBGRADE COMPACTED PER MANUFACTURER'S SPECIFICATIONS

- NOTES:
1. THIS DETAIL IS CONCEPTUAL AND FOR REFERENCE ONLY. SITE WALLS OVER 3 FEET IN HEIGHT REQUIRE SITE SPECIFIC ENGINEERING DESIGN.
  2. BARRIER RAILING TO BE SELECTED BY HOMEOWNER.
  3. BLOCK RETAINING WALL TO BE SELECTED BY HOMEOWNER.
  4. WHEN WALLS ARE TIERED, MINIMUM 5'-0" BETWEEN WALLS.

### 2 RETAINING WALL

SCALE: 1/2" = 1'-0"

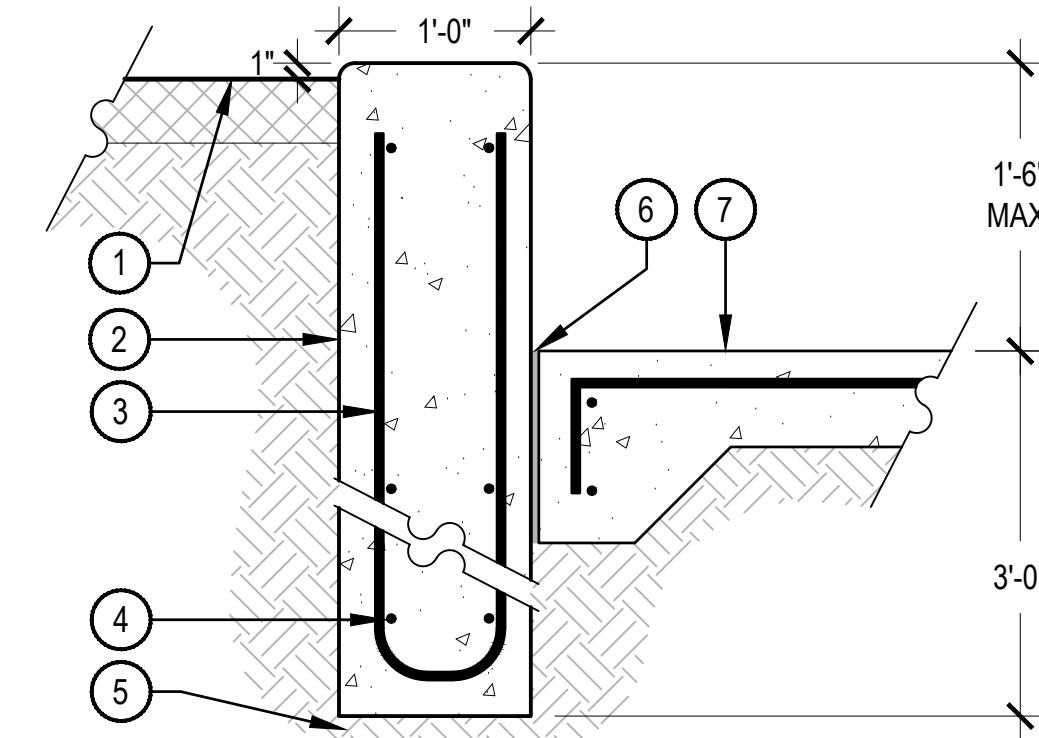

- NOTES:
1. THIS DETAIL IS CONCEPTUAL AND FOR REFERENCE ONLY. SITE WALLS REQUIRE SITE SPECIFIC ENGINEERING DESIGN.
  2. ALL CONCRETE SHALL HAVE A MINIMUM COMPRESSIVE STRENGTH OF 5,000 PSI AT 28 DAYS.
  3. MINIMUM BURY DEPTH ON ALL REBAR SHALL BE 2-1/2".
  4. VERTICAL CONTROL JOINTS SHALL BE 10' ON CENTER WITH EXPANSION JOINTS 50' ON CENTER, UNLESS OTHERWISE NOTED.
  5. VERTICAL FACES OF WALL SHALL BE PLUMB, WITH NO INCONSISTENCIES GREATER THAN 1/4" IN 10'-0" MEASURED IN ANY DIRECTION ALONG THE FACE OF THE WALL.
  6. SEATWALL SHALL BE INSTALLED SO HORIZONTAL CURVES ARE SMOOTH AND FREE-FLOWING AS SHOWN ON PLANS.

### 3 CONCRETE PLANTER SEATWALL

SCALE: 1" = 1'-0"

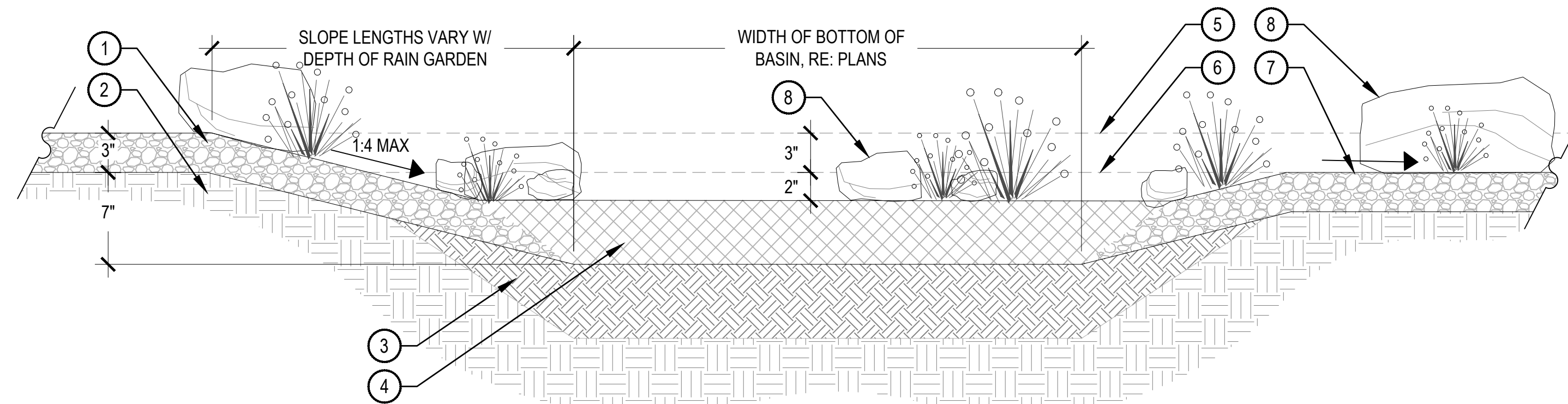

- 1 RIVER ROCK
- 2 UNDISTURBED SUBGRADE
- 3 AMENDED TOPSOIL
- 4 PEA GRAVEL MULCH
- 5 TOP ELEVATION OF BERM AROUND RAIN GARDEN, 3" ABOVE MAX PONDING LEVEL
- 6 ELEVATION OF MAX PONDING DURING STORM EVENT, PONDING 2" OF RAINWATER ABOVE PEA GRAVEL
- 7 OVERFLOW PATH AWAY FROM HOME
- 8 LANDSCAPE BOULDERS PER PLAN LAYOUT
- 9 A MIX OF 3"-10" COBBLE, SET ALONG EDGE OF RAIN GARDEN BASIN AS WELL AS IN A FEW INTERIOR AREAS TO CREATE A LOOSE, NATURALISTIC LOOK

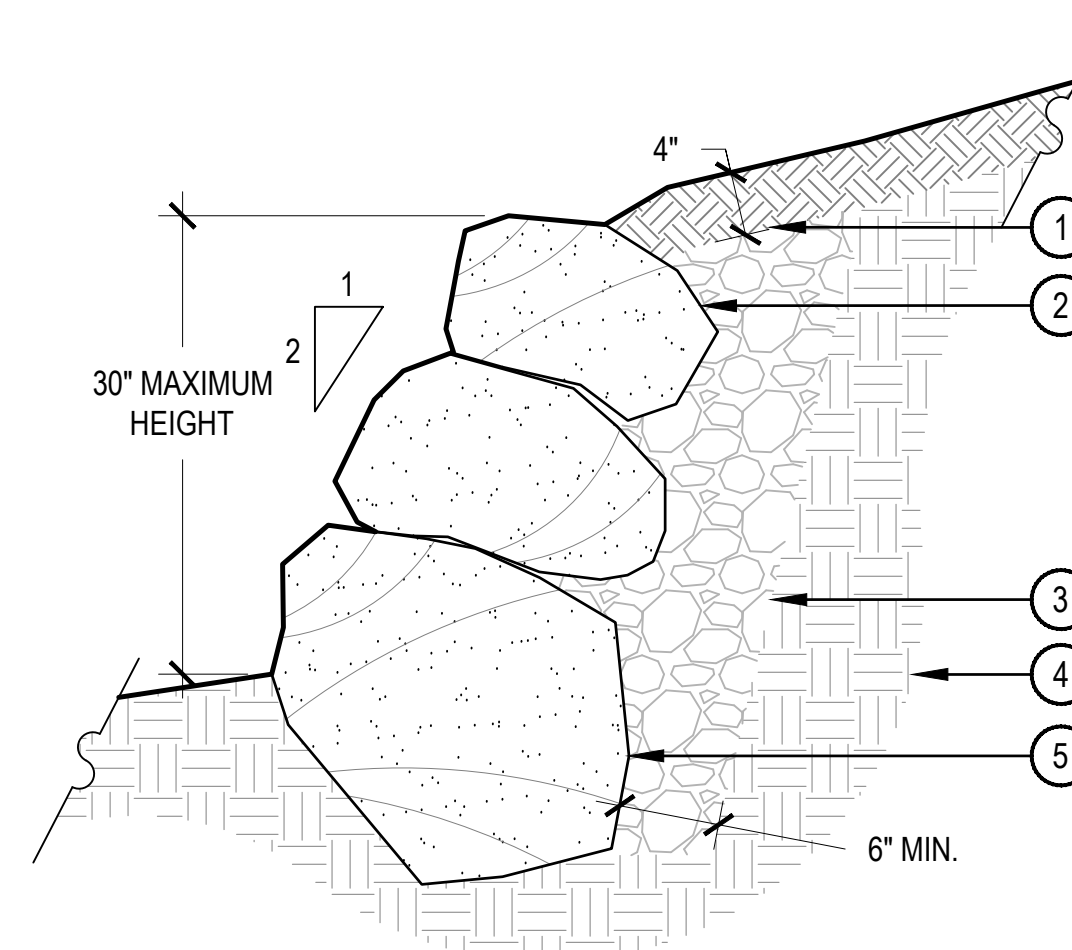

- NOTES:
1. STACK BOULDERS WITH 2:1 BATTER AND LEAN TO UPHILL SIDE, BOULDERS SHOULD BE NO SMALLER THAN 18"X18"X18".

### 5 BOULDER RETAINING WALL

SCALE: 1" = 1'-0"

### 4 RAIN GARDEN

SCALE: 1 1/2" = 1'-0"

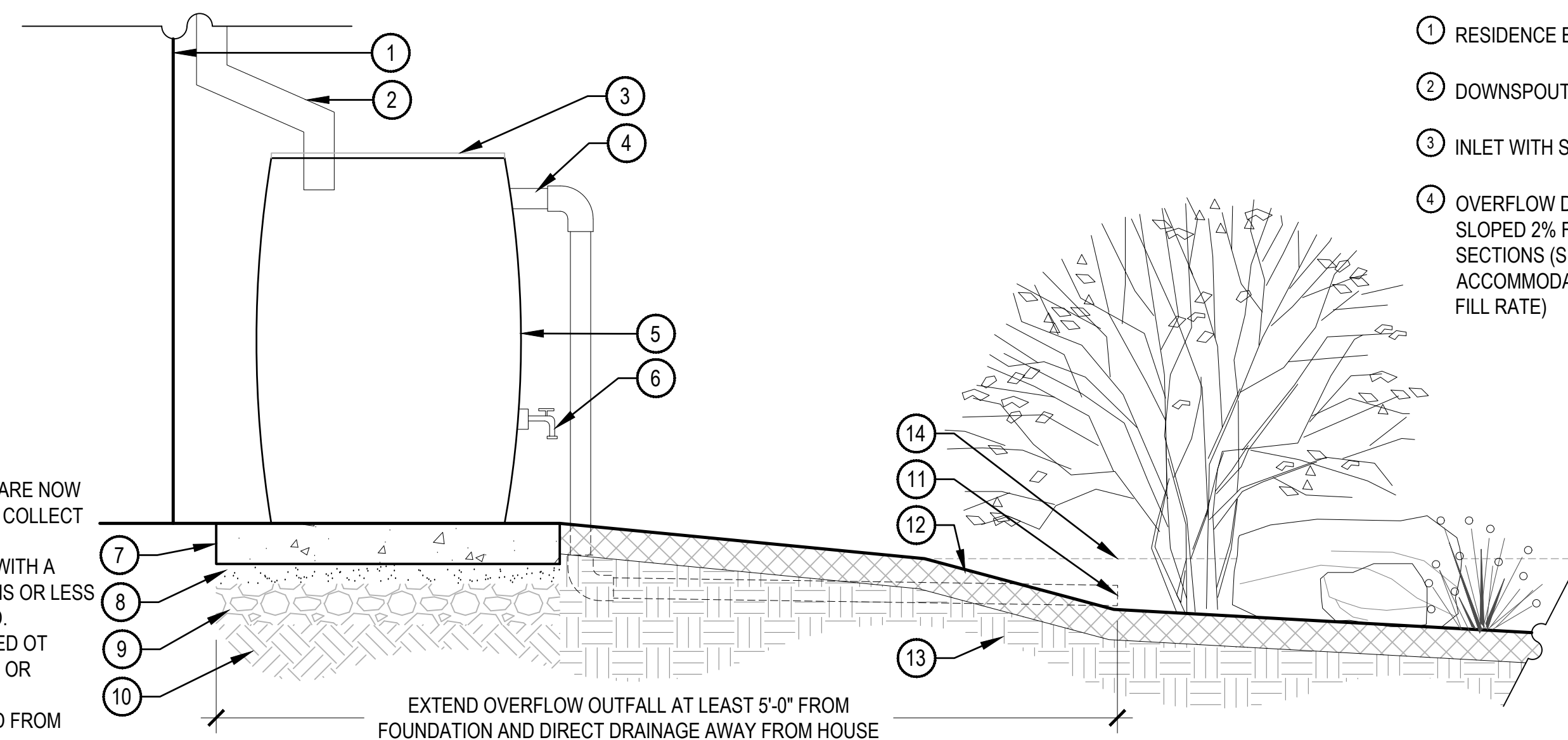

- 1 RESIDENCE BUILDING
- 2 DOWNSPOUT
- 3 INLET WITH SCREEN
- 4 OVERFLOW DRAINAGE PIPE, SLOPED 2% FOR HORIZONTAL SECTIONS (SIZE PIPE TO ACCOMMODATE RAIN WATER FILL RATE)
- 5 RAIN BARREL TANK (UP TO TWO 55-GALLON BARRELS ALLOWED)
- 6 HOSE BIB, BALL VALVE
- 7 PLATFORM, CIDER BLOCKS, BRICKS, OR POUR IN PLACE CONCRETE
- 8 PEA GRAVEL
- 9 4" ROCK MULCH
- 10 COMPACTED SUBGRADE
- 11 OVERFLOW TO OUTLET AT THE COBBLE SWALE (SEE TEMPLATE #4 PLAN)
- 12 SPECIFIED MULCH OR COBBLE, SEE PLANS
- 13 UNDISTURBED SOIL
- 14 SURROUNDING GRADE, BEHIND

- NOTES:
1. REFER TO COLORADO STATE UNIVERSITY EXTENSION, "RAINWATER COLLECTION IN COLORADO", FACT SHEET #6.707.
  2. QUICK FACTS:
    - 2.1. MOST HOMEOWNERS IN COLORADO ARE NOW ALLOWED TO USE RAIN BARRELS TO COLLECT RAINWATER.
    - 2.2. A MAXIMUM OF TWO RAIN BARRELS WITH A COMBINED STORAGE OF 110 GALLONS OR LESS ARE ALLOWED AT EACH HOUSEHOLD.
    - 2.3. COLLECTED RAINWATER MAY BE USED TO IRRIGATE OUTDOOR LAWNS, PLANTS OR GARDENS.
    - 2.4. UNTREATED RAINWATER COLLECTED FROM ROOFS IS NOT SAFE TO DRINK.

### 6 RAIN BARRELS

SCALE: 1" = 1'-0"

Plan is conceptual and subject to change.